

PARTS AND ACCESSORIES

P O BOX 71
1909 WEST MAIN STREET
WILLIAMSTON NC 27892
1-800-334-3388

www.reddickequipment.com

2020

ALL RETURN PARTS MUST HAVE RMA NUMBER

ALPHABETICAL TABLE OF CONTENTS

AGITATORS	8
BOOM ARMS	2
BOOM PARTS & ACCESSORIES	4,52
BRIGGS & STRATTON ENGINES	24
CHAIN	52
CONNECTORS	24
CONTROL UNITS	21
COUPLINGS, CAM LEVER	41
COUPLINGS, FLEXIBLE	24
DOWN DROPS	17
ELECTRONIC SPRAYER CONTROL SYSTEMS & ACCESSORIES	32-34
EYEBOLTS	52
FITTINGS, ALUMINUM	50
FITTINGS, BRASS	51
FITTINGS, NYLON	45-48
FITTINGS, POLYPROPYLENE	49
FITTINGS, ROPE WICK	48
FITTINGS, STAINLESS STEEL	50
FLUID FILM	53
HOSE AND TUBING	42,43
HOSE CLAMPS	44
HOSE NOZZLE	39
HOSE REELS	44
HYDRAULIC CYLINDERS	3
HYDRAULIC HOSE PACKAGES	3
INSERT SHEETS FOR POLYETHYLENE TANKS	5
JOHN BLUE PARTS	19
LIFT PINS	52
MANIFOLD	36
NIPPLES, ALUMINUM	53
NIPPLES, STEEL PLATED COMBINATION	24
3-NOZZLE ASSEMBLY	54
NOZZLE TIPS	26,27
PRESSURE GAUGES	35
PUMP ACCESSORIES	14
PUMPS, CENTRIFUGAL	15, 16, 18
PUMPS, DIAPHRAGM	20, 22, 26
PUMPS, SQUEEZE	18
PUMPS, HIGH PRESSURE	18
PUMPS, ATV	23
PUMPS, ROLLER	12, 13
PUMPS, DEMAND	13
QUICK TEEJET PARTS	28-30
RED BALL SPRAY MONITORS	34
SADDLES AND BANDS	5
SPRAY GUNS & ACCESSORIES	10, 11
SPRAYER ACCESSORIES	25-30
SPRAYER FRAMES	1
STRAINERS	37, 38
STRAINERS, BASKET	8, 24
TANK REPLACEMENT PARTS	8, 9
TANKS, PICKUP TRUCK	7
TANKS, POLYETHYLENE	6
TANKS, STORAGE	7
TEFLON TAPE	53
TEFLON SEALING COMPOUND	53
TRIGGER ADAPTERS	10
U BOLTS	52
VALVES, BALL	39, 40
VALVES, CHECK	30
VALVES, CONTROL	36
VALVES, FOOT	24
VALVES, PRESSURE RELIEF	31
VALVES, SOLENOID	31, 36
WILGER SPRAY MONITORS	34
WIRING HARNESS	3

SPRAYER FRAMES AND ASSEMBLIES

S2-SQT-25/55-F	25/55 GALLON SQ TUBE FRAME ASSEMBLY COMPLETE WITH TANK SADDLES AND BANDS	\$796.80
S3-T-110	FRAME ASSEMBLY FOR 110 GALLON POLY TANK COMPLETE. TALL BACK FRAME(74"	\$988.70
S3-HG-110-F	FRAME ASSEMBLY FOR 110 GALLON POLY TANK COMPLETE. LOW BACK FRAME(41 1/4"	\$886.60
S4-3032-F	STANDARD FRAME ASSEMBLY FOR 150/200 GALLON POLY TANK COMPLETE WITH TANK BANDS, SADDLES AND INSERT SHEET	\$951.70
S5-HDSK	FRAME ASSEMBLY FOR 200/300 GALLON POLY TANK COMPLETE WITH TANK BANDS, SADDLES AND INSERT SHEET	\$1143.70
S5-HDBF-3842	FRAME ASSEMBLY FOR 300 GALLON POLY TANK COMPLETE WITH TANK BANDS, SADDLES AND INSERT SHEET 38" AND 42" TANK	\$1912.70
S5-HDBF-VLBP34	VERTICAL LIFT FRAME ASSEMBLY FOR 300 GALLON POLY TANK COMPLETE WITH TANK BANDS, SADDLES AND INSERT SHEET	\$2498.00
S7/S8-F	FRAME ONLY FOR S7 & S8 300 & 500 GALLON TANK	\$1481.78
F-S7P	FRAME ASSEMBLY FOR 300 GALLON POLY TANK COMPLETE WITH AXLES, WHEELS, DRAWBAR, TONGUE, - WITH 9.5X15L TIRES	\$3517.00
F-S8P	FRAME ASSEMBLY FOR 500 GALLON POLY TANK COMPLETE WITH AXLES, WHEELS DRAWBAR, TONGUE, - WITH 11LX15 TIRES	\$3601.00



1" STANDARD ROW CROP BOOMS

B-S1-S2-S3-6	6-ROW	METAL BOOM ASSEMBLY WITH CHAIN, ROPE, PULLEYS, AND S HOOKS	\$462.00
B-S1-S2-S3-6C	6-ROW	METAL BOOM ASSEMBLY COMPLETE WITH CHAIN, ROPE, PULLEYS, S HOOKS, HOSE, HOSE CONNECTORS, HOSE CLAMPS, TIPS, STRAINERS, NOZZLE CAPS, AND NOZZLE BOOM CLAMPS	\$462.00
B-S1-S2-S3-8	8-ROW	METAL BOOM ASSEMBLY WITH CHAIN, ROPE, PULLEYS, AND S HOOKS	\$483.00
B-S1-S2-S3-8C	8-ROW	METAL BOOM ASSEMBLY COMPLETE WITH CHAIN, ROPE, PULLEYS, S HOOKS, HOSE, HOSE CONNECTORS, HOSE CLAMPS, TIPS, STRAINERS, NOZZLE CAPS, AND NOZZLE BOOM CLAMPS	\$850.00
B-S4-S7-S8-6	6-ROW	METAL BOOM ASSEMBLY WITH CHAIN, ROPE, PULLEYS, AND S HOOKS	\$607.00
B-S4-S7-S8-6C	6-ROW	METAL BOOM ASSEMBLY COMPLETE WITH CHAIN, ROPE, PULLEYS, S HOOKS, HOSE, HOSE CONNECTORS, HOSE CLAMPS, TIPS, STRAINERS, NOZZLE CAPS, AND NOZZLE BOOM CLAMPS	\$943.00
B-S4-S7-S8-8	8-ROW	METAL BOOM ASSEMBLY WITH CHAIN, ROPE, PULLEYS, AND S HOOKS	\$644.00
B-S4-S7-S8-8C	8-ROW	METAL BOOM ASSEMBLY COMPLETE WITH CHAIN, ROPE, PULLEYS, S HOOKS, HOSE, HOSE CONNECTORS, HOSE CLAMPS, TIPS, STRAINERS, NOZZLE CAPS, AND NOZZLE BOOM CLAMPS	\$1069.00

BOOM ARM ONLY

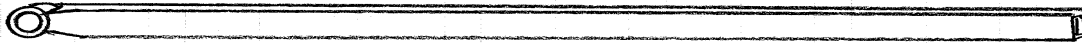

BA-100-4	1" x 4' BOOM ARM ONLY (11 GAUGE) FOR EACH ADDITIONAL FOOT-ADD	\$36.00 EACH \$2.75
BA-114-7	1 1/4" x 8' BOOM ARM ONLY (11 GAUGE) FOR EACH ADDITIONAL FOOT -ADD	\$64.00 EACH \$3.50

1 1/4" HEAVY DUTY ROW CROP BOOMS

BOOMS ARE EQUIPPED WITH HEAVY DUTY SPRINGS, DUCTILE IRON BOOM YOKES, HEAVY CAST IRON SADDLES. HYDRAULIC FOLD INCLUDING HYDRAULIC CYLINDERS AND HOSE PACKAGES. COMPLETE UNITS ARE FURNISHED WITH QUICKJET ELBOWS, AND TWO-VISIFLO NOZZLES PER ROW.

STANDARD HEAVY DUTY BOOM ASSEMBLY WITH SHOCK ABSORBERS

BHDS-8	8-ROW	METAL BOOM ASSEMBLY WITH SHOCK ABSORBERS	\$1760.00
BHDS-8C	8-ROW	METAL BOOM ASSEMBLY WITH SHOCK ABSORBERS COMPLETE WITH HOSE, NOZZLES, ETC.	\$2185.00
BHDS-12	12-ROW	METAL BOOM ASSEMBLY WITH SHOCK ABSORBERS	\$1819.00
BHDS-12C	12-ROW	METAL BOOM ASSEMBLY WITH SHOCK ABSORBERS COMPLETE WITH HOSE, NOZZLES, ETC	\$2442.00

HEAVY DUTY BOOM ASSEMBLY WITH HYDRAULIC HINGE AND SHOCK ABSORBERS (INCLUDES HYDRAULIC CYLINDERS AND HOSE PACKAGE)

BHDHS-8	8-ROW	METAL BOOM ASSEMBLY WITH HYDRAULIC FOLD AND SHOCK ABSORBERS	\$2499.00
BHDHS-8C	8-ROW	METAL BOOM ASSEMBLY WITH HYDRAULIC FOLD AND SHOCK ABSORBERS COMPLETE WITH HOSE, NOZZLES, ETC.	\$3124.00
BHDHS-12	12-ROW	METAL BOOM ASSEMBLY WITH HYDRAULIC FOLD AND SHOCK ABSORBERS	\$2380.00
BHDHS-12C	12-ROW	METAL BOOM ASSEMBLY WITH HYDRAULIC FOLD AND SHOCK ABSORBERS COMPLETE WITH HOSE, NOZZLES, ETC.	\$2975.00

OPTIONS

QJ300 SERIES TOP DIAPHRAGM CHECK BOOM FITTING.(PER ROW)
-USED IN LIEU OF QJ100 SERIES

ADD ON \$4.25

WIRING HARNESS



PART NO. (APPLICATION)	DESCRIPTION	PRICE
WH-12V-10 (12V PUMP)	10' BATTERY RING TERMINAL, #14 WIRE TO AL BOX, 1=SPST SWITCH, NO FUSE, 10' #14 WIRE TO END	49.00
WH-12V-HD-25 (12V PUMP)	8' OF 10-2 WIRE FROM 40 AMP FUSE TO AL BOX, 1=SPST SWITCH, 25' 10-2 WIRE TO SPADE ENDS	166.00
WH-1S (1= SOLENOID)	8' OF 14-2 WIRE FROM 15 AMP FUSE TO AL BOX, 1=SPST SWITCH, 18' OF 14-2 WIRE TO SPADE ENDS	103.00
WH-2S (2=SOLENOIDS)	8' OF 14-2 WIRE FROM 20 AMP FUSE TO AL BOX, 2=SPST SWITCH, 2 PC OF 18' 14-2 WIRE TO SPADE ENDS	133.00
WH-1BV (1=BALL VALVE)	8' OF 14-2 WIRE FROM 15 AMP FUSE TO AL BOX, 1=SPST SWITCH, 18' OF 14-3 WIRE TO SPADE ENDS	110.00
WH-2BV (2=BALL VALVES)	8' OF 14-2 WIRE FROM 15 AMP FUSE TO AL BOX, 2=SPST SWITCH, 2 PC OF 18' OF 14-3 WIRE TO SPADE ENDS	131.00
WH-2BV/M (2=BALL VALVES)	8' OF 14-2 WIRE FROM 15 AMP FUSE TO AL BOX, 2=SPST SWITCH + MASTER SWITCH, 2 PC OF 18' OF 14-3 WIRE TO SPADE ENDS	181.00
WH-ACT-1 (ACTUATOR)	8' OF 14-2 WIRE FROM 15 AMP FUSE TO AL BOX, 1=DPDT TOGGLE SWITCH, 18' OF 14-2 WIRE TO SPADE ENDS	136.00
WH-ACT-2 (2=ACTUATORS)	12' OF 14-2 WIRE FROM 30 AMP FUSE TO AL BOX, 2=DPDT TOGGLE SWITCHES, 2 PC OF 18' 14-2 WIRE TO SPADE ENDS	235.00
WH-SKO-12V	SKO SWITCH ASSY	54.00
WH-HR-25	HARNESS FOR ELECTRIC HOSE REEL	190.00

ACCESSORIES FOR ALL HEAVY DUTY BOOMS



HDC-2X8	HYDRAULIC CYLINDER 2 REQ EA	\$144.10			
HDC-2X10	HYDRAULIC CYLINDER	\$136.50			
HDC-2X12	HYDRAULIC CYLINDER	\$147.50			
HDC-2.5X30	HYDRAULIC CYLINDER	\$240.60	203-001	CHIEF 2"	\$46.10
HDC-3X12	HYDRAULIC CYLINDER	\$191.00	203-002	CHIEF 2 1/2"	\$49.50
			203-003	CHIEF 3"	\$54.00







HYDRAULIC HOSE PACKAGES (TRACTOR COUPLERS NOT INCLUDED)

HP-1	S4-HD, S7, AND SIDE MOUNTED SPRAYER HYDRAULIC PUMP HOSE PACKAGE	\$228.00
HP-2	S4-HD HYDRAULIC BOOM HOSE PACKAGE	\$297.00
HP-3	S7 HYDRAULIC BOOM HOSE PACKAGE	\$338.00
HP-4	RSB-3 PT. HITCH HYDRAULIC BOOM HOSE PACKAGE	\$244.00
HP-5	HOODED SPRAYER-COULTER APPLICATION-(8-ROW FOLDING TOOL BAR)	\$367.00

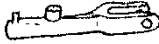

HYDRAULIC ELBOWS – 1501R-06-06-032 – RESTRICTOR ELBOW - 90 DEGREE, 3/8" MPT X 3/8" FPT SWIVEL **\$7.25**

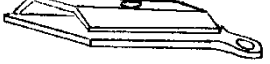
SPRAYER BOOM PARTS

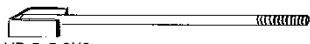
		<u>PART #</u>	<u>BOOM BREAK-AWAY HINGE PARTS</u>	<u>PRICE</u>
	YOKE	R-201	YOKE-STANDARD 1" BOOM	\$13.00
		R-202	SADDLE-STANDARD 1" BOOM	\$13.50
	SADDLE	R-100	YOKE - HEAVY DUTY 1 1/4" BOOM	\$27.10
		R-101	SADDLE-HEAVY DUTY 1 1/4" BOOM	\$20.35
		R-103	SPRING WASHER - HEAVY DUTY 1 1/4" BOOM	\$5.30
		RS-120-R	RIGHT HAND SADDLE-HEAVY DUTY HYDRAULIC 1 1/4" BOOM	\$40.20
		RS-121-L	LEFT HAND SADDLE- HEAVY DUTY HYDRAULIC 1 1/4" BOOM	\$40.20
		HB-HD	HINGE BOLT FOR RS-120 & R-101(3/4" X 13" LONG)	\$27.50
<u>FORMED HINGE PARTS</u>				
		BBH-100-TP	FORMED HINGE TOP PLATE FOR 5 X 5 (4 BUSHINGS - 3/8")	\$104.00
		BBH-100-TP2	FORMED HINGE TOP PLATE (NEW 2 BUSHINGS - 1 1/2")	\$104.00
		BBH-100-BPL	FORMED HINGE BOTTOM PLATE LEFT FOR 5 X 5	\$135.00
		BBH-100-BPR	FORMED HINGE BOTTOM PLATE RIGHT FOR 5 X 5	\$135.00
		BBH-200-TP	FORMED HINGE TOP PLATE FOR 8 X 8	\$170.00
		BBH-200-BPL	FORMED HINGE BOTTOM PLATE LEFT FOR 8 X 8	\$104.00
		BBH-200-BPR	FORMED HINGE BOTTOM PLATE RIGHT FOR 8 X 8	\$104.00
		BBH-300-TP		\$18100
		BBH-300-BPR	BBH-300-BPL	\$191.00
		HB-5X5-8X8	HINGE BOLT FOR 5 X 5 AND 8 X 8(SAME BOLT)	\$53.00

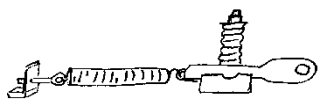
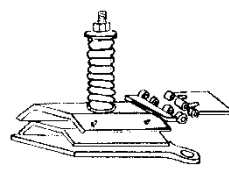
		<u>PART #</u>	<u>BOOM HINGE ASSEMBLIES</u>	<u>PRICE</u>
		BH-100	1" STANDARD BOOM HINGE ASSEMBLY COMPLETE WITH YOKES, SADDLES, SPRINGS, EYEBOLTS, ETC. (EACH)	\$70.00
		BH-114	1 1/4" HEAVY DUTY BOOM HINGE ASSEMBLY COMPLETE WITH YOKES, SADDLES, WASHERS, SPRINGS, EYEBOLTS, ETC. (EACH)	\$138.00
PLEASE STATE LEFT OR RIGHT		BHH-114-L	1 1/4" HEAVY DUTY HYDRAULIC BOOM HINGE ASSEMBLY COMPLETE WITH YOKES, SADDLES, SPRINGS, WASHERS, PIVOT BOLT ASSEMBLY, ETC. (NOT SHOWN) (EACH)	\$180.00
		BBH-100-L	1" FORMED BRIDGED BOOM HINGE ASSEMBLY COMPLETE WITH PIVOT BOLT ASSEMBLY, SPRINGS, WASHERS, YOKE PLATE, ETC. (SHOWN LEFT) (EACH)	\$214.00
		BBH-100-R		
		BBH-200-L	1 1/4" FORMED BRIDGED BOOM HINGE ASSEMBLY, COMPLETE WITH PIVOT BOLT ASSEMBLY, SPRINGS, WASHERS, YOKE PLATE WITH BUSHING. (EACH)	\$326.00
		BBH-200-R		

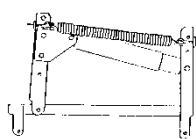
		<u>PART #</u>	<u>SHOCK ABSORBER ASSEMBLIES</u>	<u>PRICE</u>
		SA-1	SHOCK ABSORBER ASSEMBLY SINGLE (RS-199-12) SPRING OPTION FOR ALL BOOMS 12 ROWS OR LESS.(EACH)	\$277.00
		SA-2	SHOCK ABSORBER ASSEMBLY WITH TWO (RS-199-14) SPRINGS FOR ALL BRIDGED BOOMS 16 ROWS OR MORE.(EACH)	\$335.00
		HD40	REPLACEMENT SHOCK ABSORBER ONLY - NET PRICE	\$33.00

BB-SA-KIT STIFF ARM CONVERSION KIT. REPLACE CHAINS ON BRIDGED BOOM ARMS TO STIFF ARMS. STATE BOOM ARM LENGTH.(PAIR) **\$435.00**

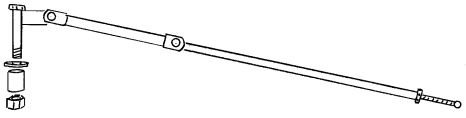

		<u>PART #</u>	<u>SPRINGS</u>	<u>PRICE</u>
		RS-199-7	EXTENSION SPRING-STANDARD 1" BOOM (15/16" O.D. x 12 1/2" LENGTH)	\$11.97
		RS-199-8	COMPRESSION SPRING-STANDARD 1" BOOM (1" O.D. x 4" LENGTH)	\$ 6.75
		RS-199-3	EXTENSION SPRING-HEAVY DUTY 1 1/4" BOOM (1 5/8" O.D. x 11" LENGTH)	\$18.00
		RS-199-11	COMPRESSION SPRING - X HEAVY DUTY 1 1/4" BOOM, BRIDGED BOOM (1 3/8" X 8 1/2")	\$20.31
		RS-199-12	EXTENSION SPRING-EXTRA HEAVY DUTY - 12 ROW BRIDGED BOOM (1 3/4" O.D. x 11 1/8" LENGTH)	\$14.25
		RS-199-16	EXTENSION SPRING XX HEAVY DUTY - 16 ROW BRIDGED BOOM(1 15/16" O.D. X 11 3/4" LENGTH)	\$22.00
		RS-199-14	TAPERED EXTENSION SPRING - 16 ROW BRIDGED BOOM (1 7/8" O.D. X 11 3/4" LENGTH) 2 REQ'D FOR SA-2	\$20.61
		RS-199-14-KIT	RETRO FIT SHOCK ASSEMBLY. SINGLE CONVERSE SPRING ASSY TO DOUBLE SPRING ASSY ON BRIDGED BOOM SHOCK ASSY. ONE KIT REQUIRED FOR 2 SHOCK ASSY.	\$179.19

SADDLE AND BAND ASSEMBLIES INSERT SHEET

SADDLE AND BAND ASSY. FOR ROUND TANKS

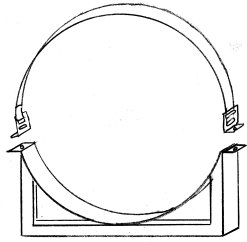

NOTE: 2 OR MORE SADDLES AND BANDS REQUIRED FOR MOST TANKS

INSERT SHEET AND BAND ASSY. FOR OVAL TANKS

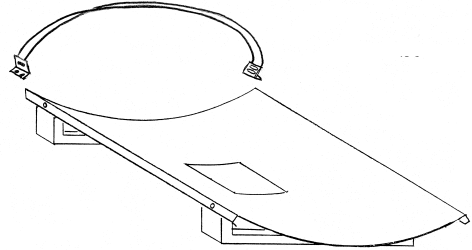

PART NO.	FOR ROUND TANKS	REQ'D #	PRICE
RS-23-L	FITS 23" DIAMETER TANK(LOW PROFILE)	2	113.00
RS-30	FITS 30" DIAMETER TANK	2	132.00
RS-32	FITS 32" DIAMETER TANK	2	128.00
RS-38	FITS 38" DIAMETER TANK	2	149.00
RS-42	FITS 42" DIAMETER TANK	2	184.00
RS-48	FITS 48" DIAMETER TANK	2	191.00
FOR OVAL TANKS			
RSO-150	FITS 150 GALLON OVAL TANK(35.5 X 53)	1	405.00
RSO-200	FITS 200 GALLON OVAL TANK(39.5 X 63)	1	435.00
RSO-300	FITS 300 GALLON OVAL TANK(43.7 X 57)	1	509.00
RSO-400	FITS 400 GALLON OVAL TANK(44 X 60)	1	561.00
RSO-500	FITS 500 GALLON OVAL TANK(43.5 X 70)	1	561.00
RSO-750	FITS 750 OVAL (69 X 42 X 88)	1	701.00
RSO-1000	FITS 1000 GALLON OVAL TANK(78 X 49 X 90)	3	792.00

FOR ROUND TANKS – SADDLE AND BANDS MAY BE PURCHASED SEPARATELY
ADD S FOR SADDLE ONLY OR ADD B FOR BAND ONLY EX: RS-32-S

FOR OVAL TANKS - INSERT SHEET ONLY ADD LB EX: RSO-300-LB
FOR BAND ONLY PART NUMBER BEGINS WITH ROB EX: ROB-300

SPACE SAVER SADDLE TANKS

RS-24X150SS	150 GALLON SADDLE AND BAND ASSY (COMPLETE FOR 2 TANKS)	1160.00
RS-24X200SS	200 GALLON SADDLE AND BAND ASSY (COMPLETE FOR 2 TANKS)	1224.00
RS-24X250SS	250 GALLON SADDLE AND BAND ASSY (COMPLETE FOR 2 TANKS)	1291.00

INSERT SHEETS FOR POLYETHYLENE TANKS(ONE REQ'D PER TANK)

RI-85-23	30" X 50" INSERT SHEET – FITS 23" X 85 GALLON ROUND TANK	123.00
RI-110-30	30" X 40" INSERT SHEET – FITS 30" X 110 GALLON ROUND TANK	73.00
RI-150/200-3032	30" X 50" INSERT SHEET – FITS 30" X 150 & 200 GALLON ROUND TANK	105.00
RI-200-38	36" X 40" INSERT SHEET – FITS 38" X 200 GALLON ROUND TANK	139.00
RI-300-38	40" X 50" INSERT SHEET – FITS 38" X 300 GALLON ROUND TANK	131.00
RI-400-42	48" X 60" INSERT SHEET - FITS 42" X 400 GALLON ROUND TANK	115.00
RI-500-42	48" X 78" INSERT SHEET – FITS 42" X 500 GALLON ROUND TANK	167.00
RI-500-48	60" X 48" INSERT SHEET – FITS 48" X 500 GALLON ROUND TANK	132.00

NO ADDITIONAL INSERT SHEET REQUIRED FOR OVAL TANKS



POLYETHYLENE TANKS

TANKS NO LONGER INCLUDE TANK FITTINGS. PLEASE SPECIFY THE SIZE OF FITTING FOR YOUR TANK. TANK FITTINGS ARE EXTRA COST.

PART NO. YELLOW	WHITE	GALLONS	W X H X L	TYPE	LID	WT	PRICE
47029	47030	15 L & G	15"W x 11"H x 30"L		5"	10	111.55
47033	47031	25 L & G	20"W x 14"H x 30"L		5"	15	130.80
42321		5 SQ	11"W X 18"H X 11"L		8"	6	74.75
42351		10 SQ	13"W X 21"H X 13"L		8"	11	103.35
47036		9	10" x 14" x 20"	FRESH WATER		9	236.80
47006		25	23" x 19"	HORIZONTAL	5"	12	107.85
47337		55	23" x 37"	HORIZONTAL	5"	18	177.10
47394		85	23" x 55"	HORIZONTAL	5"	26	280.80
47368	47374	110	30" x 44"	HORIZONTAL	10"	36	290.00
47327		150	30" x 56"	HORIZONTAL	10"	44	368.25
47068		200	32" x 65"	HORIZONTAL	10"	66	448.60
47325		200	38" x 47"	HORIZONTAL	10"	60	448.60
47375	47409	300	38" x 69"	HORIZONTAL	10"	83	590.55
47331	47699	400	42" x 76"	HORIZONTAL	10"	100	849.75
47330	47474	500	48" x 74"	HORIZONTAL	10"	120	862.85
47335		500	42" x 93"	HORIZONTAL	10"	147	935.75
41346		15	19" x 23"	MIX-N-FILL	8"	9	111.50
42086	42064	15	24" X 21"	MIX-N-FILL	16"	10	125.30
42087	42065	30	24" x 28"	MIX-N-FILL	16"	14	148.45
62438		35	23" x 29"	MIX-N-FILL	8"	14	136.30
41340		60	31" x 32"	MIX N FILL	16"	22	201.65
47373		80	32" X 34"	MIX N FILL	16"	30	279.20
47024	47023	15	12"W x 15"H x 25"L	PCO	5"	10	136.80
47022	47021	30	19"W x 20"H x 25"L	PCO	5"	16	178.30
47097	47260	50	19"W x 20"H x 38"L	PCO	5"	23	200.75
47098	47181	100	30"W x 26"H x 38"L	PCO	5"	42	322.35
47350	47364	150	36"W x 26"H x 48"L	PCO	10"	63	398.00
47352	47261	200	36"W x 35"H x 48"L	PCO	10"	76	498.90
47359	47258	300	36"W x 35"H x 69"L	PCO	16"	109	1072.60
47342	47710	150	38½"W x 24"H x 56"L	OVAL	10"	55	478.30
47086	47711	200	40"W x 26"H x 66"L	OVAL	10"	80	544.80
47349	47754	300	48"W x 30"H x 70"L	OVAL	16"	110	714.50
47389	47183	400	57"W x 36"Hx70"L	OVAL	16"	126	815.35
47346	47085	500	57"W x 36"H x 82"L	OVAL	16"	150	1025.80
47076		750	69"W X 42"H X 88"L	OVAL	16"		1446.25
47103	47105	1000	78"W x 49"H x 90"L	OVAL	16"	282	1834.00
	47288(B)						1934.00
47345		150 CAW	24"W x 41"H x 49"L	SPACE SAVER	10"	69	464.55
47344	47121	200 CAW	24"W x 47"H x 54"L	SPACE SAVER	10"	85	512.70
47340	47448	250 CAW	24"W x 53"H x 60"L	SPACE SAVER	10"	100	620.45

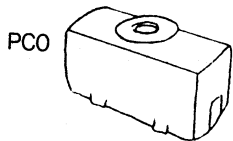

PCO

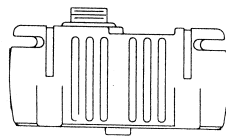

LAWN AND GARDEN



FRESH WATER

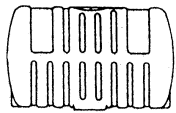

HORIZONTAL

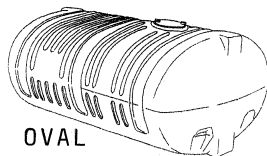

OVAL

SPACE SAVER

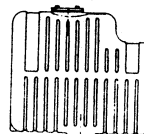

MIX-N-FILL

POLYETHYLENE STORAGE TANKS

FEATURES: VERTICAL
 ONE PVC/NYLON FITTING
 INCLUDED WITH DIP TUBE.
 *MOLDED IN GALLONAGE INDICATORS
 *STANDARD COLOR: YELLOW OR WHITE
 *STANDARD WALL HOLDS 11 PPG.
 *HEAVY DUTY WALL HOLDS 13 PPG AVAILABLE
 *2" OUTLET

FEATURES: HORIZONTAL- NURSE/LEG
 *MOLDED-IN BAFFLES
 *DESIGNED WITH SELF-SUPPORTING MOLDED-IN LEGS
 *COLORS: YELLOW OR BLACK (EXTRA \$50 NET CHARGE FOR BLACK TANK-)
 *2" OUTLET

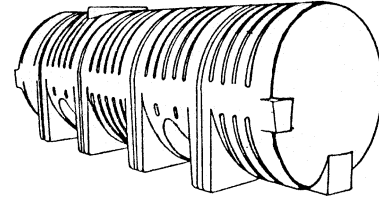
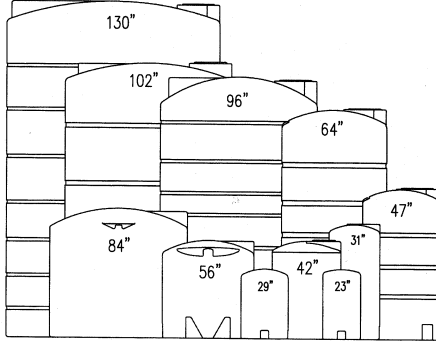

HORIZONTAL LEG

PART NO.	GALLO NS	LID	D X L	TYPE	WEIGH T	PRICE
41347	65	8"	23" x 42"	VERTICAL	18	191.78
47333	110	10"	29" x 42"	VERTICAL	36	279.11
40337	550	16"	67" X 42"BLACK	VERTICAL	128	923.50
40341	1550	16"	87" x 67"BLACK	VERTICAL	276	1778.54
41891	35	5"	20"x 29"	LEG	15	122.50
45197	65	5"	23" x 43"	LEG	57	229.64
40772	125	8"	32" x 41"	LEG	40	373.90
41344	225	8"	38" x 49"	LEG	75	552.78
41345	325	16"	38" x 68"	LEG	95	683.46
47358	500	16"		LEG		980.34
47885	500	16"	48" x 75"BLACK	LEG	172	1080.34
47937	750	16"	48" x 107"BLACK	LEG	246	1614.88
W X H X L						
47382	1000	16"	48" x 51" x 139"BLACK	LEG	302	2154.18
47821	1650	16"	62" x 65" X 139"BLACK	LEG	400	3742.40
HEAVY WEIGHT TANKS (PRICE IS PICKED UP IN WILLIAMSTON)						
1635-41890	1635	16"	71" x 58" x 142"BLACK	ELLIPTICAL LEG	515	3604.54
40775	2035	16"	84" x 56" x 142"	ELLIPTICAL LEG	660	4503.14
41294	2635	16"	90" x 72" x 140"	ELLIPTICAL LEG	922	6315.64
3135-41417	3135	16"	88" x 80" x 150"	ELLIPTICAL LEG	1072	6961.46
45366	2650	22"H	88" x 82" x 122"	ELL LEG BAFFLE	1150	6899.02
44603	3250	22"H	88 X 82 X 152	ELL LEG BAFFLE	1150	7516.86
42011	4035	16"H	92 X 75 X 152	ELLIPTICAL LEG	1150	9799.08

HOOP ASSEMBLY FOR NURSE TANKS

PART NO.	GALLONS	REQUIRE	PRICE EACH
61744	125	2 HOOPS	54.52
60478	225, 325	2 HOOPS	89.66
67101	500	2 HOOPS	93.90
67101	750	3 HOOPS	93.90
67101	1000	4 HOOPS	93.90
63282	1325	3 HOOPS	137.90
67246	1650	4 HOOPS	122.34
64191	1635	4 HOOPS	128.42
63840	2035	4 HOOPS	222.52
60353	2635	4 HOOPS	286.22
62097	2650(3) 3135	4 HOOPS	311.48
62832	4035	4 HOOPS	328.26
60520	35	2 HOOPS	25.14
61745	65	2 HOOPS	37.88

TANK COVERS AND FILLWELLS

	67410	2 1/4" CAP FOR 10 GAL. TANK(NOT SHOWN)	\$14.70
	60366	EPDM GASKET 5"LID FOR 63484	\$6.78
	63484	5" COVER FOR NORWESCO TANK W/BALL CHECK AND GASKET	\$11.49
	60002	8" COVER THREADED – BLACK(PRIOR 2008)	\$17.89
	63480	8" LID WITH BLUE SNAP IN VENT	\$13.84
	67399	10" COVER THREADED - BLACK	\$23.55
	67400	10" FILLWELL, THREADED – BLACK	\$15.52
  	60019	4" BREATHER CAP ONLY - BLACK	\$13.53
	60011	16" COVER W/BREATHER CAP - BLACK	\$32.32
	60012	16" FILLWELL, THREADED - BLACK	\$10.22
	63485	16" LID AND RING W/BLUE SNAP-IN VENT	\$35.33
	62531	18" LANYARD FOR 8" & 16" NON HINGED LID	\$1.36
STRAINER BASKETS			
 67375	14 MESH HEAVY DUTY NYLON FITS INSIDE THE FILLWEL		\$73.63
	 67374	67375	
		67374	16" BASKET

AGITATORS

3371	1/2" FPT JET AGITATOR - NYLON	\$6.88
3371-0019	3/4" MPT JET AGITATOR - NYLON	\$7.87
6290SC-3-AL	1/4" FPT AGITATOR ALUMINUM	\$46.57
DTA-33C	TWIN DROP TUBE AGITATION W/TANK FITTING FOR 38" DIAMETER TANK	\$41.50
DTA-33	TWIN DROP TUBE AGITATION ASSY. LESS TANK FITTING	\$34.00
Y33180-PP	TEEJET MIXING NOZZLE - 3/8" PIPE THREAD	\$73.88

KEEPS WETTABLE POWDERS IN SUSPENSION WITHOUT FOAMING AND INCREASES EFFECTIVE INPUT FLOW UP TO 3 TIMES FOR THOROUGH AGITATION.

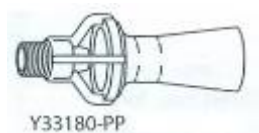

DTA-33



TANK REPLACEMENT PARTS

NORWESCO FITTINGS

PART#	DESCRIPTION	PRICE
62834	1/2" DOUBLE THREAD	6.92
60401	3/4" DOUBLE THREAD	5.41
60402	EPDM GASKET FOR 3/4"	1.20
60360	VITON GASKET FOR 3/4"	23.54
60427	1" DOUBLE THREAD	6.92
60403	1 1/4" DOUBLE THREAD	6.78
63065	1 1/4" ANTI VORTEX	8.66
60404	EPDM GASKET FOR 1" AND 1 1/4"	1.67
60361	VITON GASKET FOR 1" AND 1 1/4"	35.33
60124	1 1/2" DOUBLE THREAD	10.37
60405	2" DOUBLE THREAD	9.88
62399	2" ANTIVORTEX ADAPTER	3.66
60406	EPDM GASKET FOR 1 1/2" AND 2"	2.36
60523	VITON GASKET FOR 1 1/2" AND 2"	50.06
60335	2" SIPHON TUBE, SHORT	6.63
63683	2" HEAVY DUTY DT FITTING	17.53
60336	EPDM GASKET FOR 2"	3.68
60008	VITON GASKET FOR 2"	55.96
62299	3" DOUBLE THREAD	53.01
60331	EPDM GASKET FOR 3"	9.48
60351	VITON GASKET FOR 3"	72.01
60327	3" SIPHON TUBE, SHORT	14.29
62171	4" DOUBLE THREAD	164.98
62714	4" SIPHON TUBE	129.62

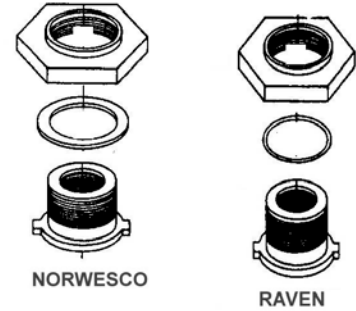

NORWESCO TANK FITTING SIZE
PURCHASED AFTER JANUARY 1, 2004

FITTING SIZE	HOLE SIZE
1/2" & 3/4"	1 1/2"
1", 1 1/4"	2 1/4"
1 1/2"DT, 2"DT	3"
2" HD/TUBE	3 1/4"
3"	4 5/8"

USE A STANDARD HOLE SAW THAT FITS ANY 1/4"
ELECTRIC DRILL MOTOR TO CUT THE PROPER SIZE
HOLE.

PART#	DESCRIPTION	PRICE
60081	SCREWS	0.30
62531	TIE DOWN FOR COVER	1.33
67244	3/4" WATER SPIGOT FOR 9 GALLON FRESH WATER TANK	7.37

HANDGUNS AND ACCESSORIES

TEEJET MODEL 43: DESIGNED FOR HEAVY DUTY SERVICE IN LANDSCAPE, ORCHARD, NURSERY, EQUIPMENT CLEANING, AND SPOT SPRAYING APPLICATIONS. NOZZLE ADJUSTS FROM FINE CONE MIST TO STRAIGHT STREAM. KNURLED ADJUSTMENT RING ALLOWS TRIGGER TO BE LOCKED IN ANY DESIRED POSITION. 1/2" FPT INLET. BRASS OR ALUMINUM MATERIAL. REPAIR PARTS IN BLUE SECTION PAGE 1.



AA43LA

LOW PRESSURE (200 PSI MAX)

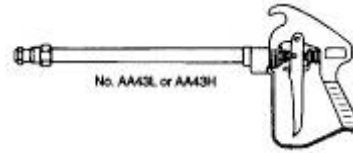

No. AA43L or AA43H

HIGH PRESSURE (800 PSI MAX)

MODEL	MATERIAL	LENGTH	PRICE	MODEL	MATERIAL	LENGTH	PRICE
AA43LA-6	BRASS	13"	184.94	AA43HA-6	BRASS	13"	184.96
AA43L-6	BRASS	22"	204.13	AA43H-6	BRASS	22"	204.13
AA43LA-AL6	ALUMINUM	13"	162.45	AA43HA-AL6	ALUMINUM	13"	162.45
AA43L-AL6	ALUMINUM	22"	169.60	AA43H-AL6	ALUMINUM	22"	169.60

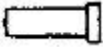

ACCESSORIES

QUICK COUPLERS

	11990-19 1/2" NPT M X F SWIVEL CONNECTOR TO FIT NO.43 GUN	\$43.73
	DXHSS HARDENED STAINLESS STEEL NOZZLE TO PROVIDE MAXIMUM SPRAY THROW. FITS NO.43 GUN. SPECIFY SIZE 6,8,10, OR 12	\$29.47

PART#	STYLE	INLET	PRICE
38FS	SOCKET	3/8 FPT	10.75
38MS	SOCKET	3/8 MPT	10.04
38FPB	PLUG	3/8 FPT	4.50
38MPB	PLUG	3/8MPT	3.60
50FS	SOCKET	1/2 FPT	15.20
50MS	SOCKET	1/2 MPT	13.01
50FPB	PLUG	1/2 FPT	5.50
50MPB	PLUG	1/2 MPT	6.30

REUSABLE ENDS

	PART# 4D7 3/8" MALE RIGID 6P13 1/2" MALE RIGID	PRICE 6.45 10.65	JD-9 \$134.00 HANDGUN-ECONOMY VERSION WITH 1/2" FPT JD9-C \$233.40 ORIGINAL HANDGUN -HEAVY DUTY COMMERCIAL WITH 3/4" GHT AND 1/2" FPT JD9-CT GAUGE PORT \$240.15	
	2B7MS 1/4" MALE SWIVEL 4D7MS 3/8" MALE SWIVEL 6P13MS 1/2" MALE SWIVEL	8.20 9.80 16.80		



HOODED SPRAY WAND

PART # 4.802.30

\$123.60

POLYPROPYLENE TRIGGER VALVE, 3/8" HOSE BARB INLET. STRAINER IN HANDLE. 28" STAINLESS STEEL SPRAY WAND. PLASTIC SPRAY SHIELD PROTECTS AGAINST OVERSPRAY AND DRIFT. INCLUDES 8002 SPRAY TIP WITH QUICK CONNECT CAP. MAX GPM-5, MAX PSI-300

Lesco Chemlawn Spray Gun (Less Tip)



PART # 5001-S \$95.40

USE IN YOU LANDSCAPING LAWN CARE AND OUTDOOR GREEN SPACE MAINTENANCE JOBS. THIS SPRAY GUN IS A LIGHTWEIGHT PERFORMER, WEIGHING IN AT ONLY 2 LBS. AND WITH ITS CONSTRUCTION FROM POLY MANTERIALS, IT'S EASY TO GRIP AND STANDS UP TO CONTINUAL USAGE IN YOU FREQUENT SPRAYING JOBS.

MAX PRESSURE: 200 PSI

INLET: 1/2" NYLON HOSE BARB 3/4" FNPT WHEN BARB IS REMOVED

WEIGHT: 2 LBS

TIP NUMBER & COLOR	GPM	PRICE
#018104 BLUE	1.5	16.00
#009510 YELLOW	2	16.00
#007668 GREEN	3	16.00
#007655 WHITE	4	16.00



HANDGUN PARTS



#30-CPT#1 ROLLOVER HANDGUN **\$156.00**
INCLUDES #30 HANDGUN, 11/16 MALE INLET, ROLLOVER VALVE WITH ONE 4004SS TIP AND ONE HOLLOW CONE NOZZLE WITH SS INSERT



5500-BR/SS-X6 HOLLOW CONE NOZZLE **\$27.74**

RO-CPT ROLLOVER VALVE COMPLETE **\$122.75**
INCLUDES VALVE SS FLAT FAN, HOLLOW CONE WITH SS INSERT

4990390 ROLLOVER SWIVEL ONLY **\$80.00**

TP4004-SS FLAT FAN SPRAY TIP **\$12.86**

LIGHTWEIGHT TRIGGER HANDGUNS AND TRIGGER VALVES



	22650-PP-300 \$33.50 1/4" HOSE SHANK		22670-PP-15-300 \$52.79 22670-PP-24-300 \$60.85 1/4" HOSE SHANK
22650 22650-PP-1/4 \$33.50 1/4" F NPT	22650-PP-406 \$33.50 3/8" HOSE SHANK	22670-PP 22670-PP-15-1/4 \$52.79 22670-PP-24-1/4 \$60.85 1/4" F NPT	22670-PP-15-406 \$52.79 22670-PP-24-406 \$60.85 3/8" HOSE SHANK

TEEJET TRIGGER JET SPRAY GUN: LIGHTWEIGHT POLYPROPYLENE SPRAY GUN FOR LOW PRESSURE APPLICATIONS. CHOICE OF 1/4", 3/8" HOSE SHANK OR 1/4" FEMALE NPT CONNECTION. GUN WILL ACCEPT STANDARD SPRAY TIPS. MAX 150 PSI. MODEL 22670 HAS ADJUSTABLE NOZZLE AND EXTENSION OF 15" OR 24". CHOOSE HOSE BARB SIZE A1414, A1438 OR A1412.

	50800-15-PP-300 TRIGGERJET \$19.29 LIGHTWEIGHT POLYPROPYLENE HANDGUN WITH LOCKING TRIGGER AND ADJUSTABLE NOZZLE. 15" EXTENSION WAND, MAX 100 PSI, AND 1/4" HOSE SHANK CONNECTION.
	SG-4539F ECONOMY SPRAY GUN \$15.65 LIGHTWEIGHT POLYPROPYLENE HANDGUN WITH 22" EXTENSION WAND AND ADJUSTABLE CONE TIP.

TEEJET ADJUSTABLE CONE TIP			
38720-PPB-X18	\$7.85	5500-X3	\$23.33
5500-PPB-X8-VI	\$12.20	X5, X8, X10, X12, X26	
5500-PPB-X8	\$10.64		



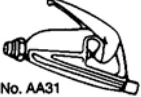

4688 TRIGGER TEEJET VALVE \$56.88 SAME AS ABOVE EXCEPT (F) INLET - (M) OUTLET. 	6104 TRIGGER TEEJET VALVE \$56.36 FLOW RATES UP TO 2 GPM AND PRESSURES UP TO 250 PSI. BRASS 1/4" CONNECTIONS 	AA31-1/4F GUNJET \$88.97 BRASS WITH 1/4" (M) INLET AND 11/16" OUTLET FOR 5500 NOZZLE OR TEEJET CAP AND TIP 
--	---	---

1215.29 	UDOR HEAVY DUTY SPRAY GUN ADJUSTABLE SPRAY TO A CONE MIST. MAX PSI 350 MAX GPM 16 1215.29	\$177.16
---	---	-----------------

UDOR HIGH PERFORMANCE SPRAY GUNS

THESE GUNS OFFER VARIABLE SPRAY PATTERN ADJUSTMENT RANGING FROM A WIDE ANGLE CONE MIST TO A LONG-REACHING SOLID STREAM. SPRAY CAPACITIES RANGE FROM 1 GPM TO 30 GPM. ALL MODELS ARE RATED AT 850 PSI MAX.

		
26.901.162 \$183.75 TURBO GUN BARREL LENGTH 8" MAX CAPACITY 15 GPM	7.901.103 \$249.78 TURBINE GUN BARREL LENGTH 17" MAX CAPACITY 25 GPM	13.901.151 \$349.38 LONG RANGE BARREL LENGTH 21" MAX CAPACITY 30 GPM
REPAIR KIT 8711.03 \$26.06	REPAIR KIT KIT-10/11 \$31.00	REPAIR KIT KIT-10/11 \$31.00

HYPRO ROLLER PUMPS

	6500	SERIES 6500 PUMPS 6 ROLLER PORT SIZE: 3/4" NPT 1" HB INLET FITTING FOR 1000 RPM OPERATION ROLLERS: SUPER ROLLERS STANDARD SHAFT SEALS: VITON STANDARD WEIGHT: 9LBS MAX PSI: 300 MAX GPM: 21.8 MAX RPM: 1200 SHAFT: 5/8"		PRICE
		6500C	CAST IRON PUMP	\$244.40
		6500N	NI-RESIST PUMP	\$554.40
		6500XL	SILVER CAST PUMP	\$765.45
		6500XL-R	REVERSE ROTATION	\$774.90

	7560	SERIES 7560 PUMP 8 ROLLER PORT SIZE: 3/4" NPT 1" HB INLET FITTING FOR 1000 RPM OPERATION ROLLERS: SUPER ROLLERS STANDARD SHAFT SEALS: VITON STANDARD WEIGHT: 13 LBS MAX PSI: 300 MAX GPM: 22.5 MAX RPM: 1000 SHAFT: 15/16"		
		7560C	CAST IRON PUMP	\$319.28
		7560N	NI-RESIST PUMP	\$628.95
		7560XL	SILVER CAST PUMP	\$912.45
		7560XL-R	REVERSE ROTATION	\$921.90

	7700	SERIES 7700 PUMPS 7 ROLLER PORT: SIZE: 3/4" NPT SHAFT ROTATION: COUNTER CLOCKWISE WHEN LOOKING AT THE SHAFT END ROLLERS: SUPER ROLLERS STANDARD SHAFT SEALS: VITON STANDARD WEIGHT: 14 LBS MAX PSI: 200 MAX GPM: 22.1 MAX RPM: 800 SHAFT: 15/16"		
		7700C	CAST IRON PUMP	\$324.48
		7700N	NI-RESIST PUMP	\$628.95
		7700XL	SILVER CAST PUMP	\$934.50
		7700XL-R	REVERSE ROTATION	\$945.00

	1500	SERIES 1500 PUMPS 6 ROLLER PORT SIZE: 1 1/2" NPT SHAFT ROTATION: COUNTER CLOCKWISE WHEN LOOKING AT THE SHAFT END ROLLERS: SUPER ROLLERS STANDARD SHAFT SEALS: BUN-A ON CAST IRON AND NI- RESIST AND VITON ON XL SERIES WEIGHT: 30 LBS MAX PSI: 200 MAX GPM: 62 MAX RPM: 1000 SHAFT: 15/16"		
		1502C	CAST IRON PUMP	\$775.84
		1502N	NI-RESIST PUMP	\$1282.05
		1502XL	SILVER CAST PUMP	\$1748.25
		1502XL-R	REVERSE ROTATION	\$1759.80

	1700	SERIES 1700 5 ROLLER PORT SIZE: 1" NPT SHAFT ROTATION: COUNTER CLOCKWISE WHEN LOOKING AT THE SHAFT SHAFT SEALS: VITON STANDARD ROLLERS: SUPER ROLLERS WEIGHT: 19 LBS MAX PSI: 200 MAX GPM: 45 MAX RPM: 1000 SHAFT: 15/16"		
		1700C	CAST IRON PUMP	\$505.44
		1700N	NI-RESIST PUMP	\$1043.70
		1700XL	SILVER CAST PUMP	\$1394.45
		1700XL-R	REVERSE ROTATION	\$1407.00

SEE BLUE SECTION FOR PARTS BREAKDOWN

4001/4101

HYPRO HIGH SPEED, 4 ROLLER PUMPS



PORT SIZE: 3/4" NPT
 PUMP SHAFT ROTATION" CLOCKWISE WHEN LOOKING AT THE SHAFT END
 ROLLERS: SUPER ROLLERS STANDARD
 SHAFT SEALS: VITON STANDARD
 WEIGHT: 5 LBS

4001 RPM: 1800
 4101 RPM: 2600
 MAX PSI: 150

4001C	CAST IRON PUMP ONLY	\$244.40	4101C	CAST IRON PUMP ONLY	\$225.68
4001N	NI-RESIST PUMP ONLY	\$416.85	4101N	NI-RESIST PUMP ONLY	\$402.15
4001XL	SILVER CAST PUMP	\$609.00	4101XL	SILVER CAST PUMP	\$594.30

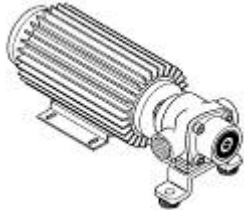

HYPRO ROLLER PUMP WITH 12 VOLT MOTOR

ALL MODELS COME IN EITHER NI-RESIST OR SILVER SERIES XL
 SUPER ROLLERS AND VITON SEALS STANDARD
 LOCKING COLLAR AND TORQUE ARM COME IN EACH PACKAGE
 WEIGHT: 16-18 LBS

4101N-EH(PUMP AND 12 VOLT MOTOR)	\$882.00
4101XL-EH(PUMP AND 12 VOLT MOTOR)	\$1071.00
4101XL-H(PUMP ONLY)	\$594.00

EVERFLO 12 VOLT PUMP

POLYPROPYLENE PUMP HOUSING AND VALVE PLATE, VITON VALVES, SANTOPRENE DIAPHRAGM



EF1000-BOX	1.0 GPM, 12V DIAPHRAGM PUMP BOXED - 3/8" BARB	\$71.51
EF2200-BOX	2.2 GPM, 12V DIAPHRAGM PUMP BOXED - 3/8" FNPT	\$135.76
EF2200-QA-BOX	2.2 GPM, 12V DIAPHRAGM PUMP BOXED - QUICK ATTACHED	\$140.75
EF3000-BOX	3.0 GPM, 12V DIAPHRAGM PUMP BOXED - 1/2" FNPT	\$181.12
EF5500-BOX	5.5 GPM, 12V DIAPHRAGM PUMP BOXED - 1/2" FNPT	\$305.75
EF7000-BOX	7.0 GPM, 12V DIAPHRAGM PUMP BOXED - 1/2" FNPT	\$509.85

DEMAND PUMPS

SHURFLO AND DELAVAN DIAPHRAGM PUMPS PROVIDE EXCEPTIONAL PERFORMANCE AND RELIABILITY AT LOW COST. ALL MODELS LISTED WITH CHEMICAL RESISTANT VITON VALVES, SANTOPRENE DIAPHRAGMS. PRESSURE SENSITIVE SWITCH AUTOMATICALLY SHUTS DOWN PUMP WHEN MAXIMUM PRESSURES ARE REACHED.

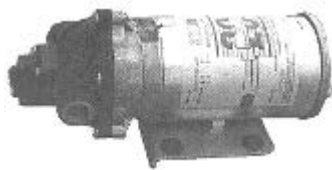

SHURFLO	VOLTAGE	PORT SIZE	GPM	PSI	PRICE
8000-543-236	12VDC	3/8" F	1.8	60	\$160.55
2088-343-135	12VDC	1/2" M	3.0	45	\$191.59
2088-313-145	12VDC	1/2" M	3.6	45	\$314.68
8000-533-236	115AC	3/8" F	1.4	60	\$216.30
5059-1310-D011	12VDC	1/2" F	5.3	60	\$260.04

WH-SKO-12V SWITCH ASSEMBLY FOR SHURFLO PUMPS \$57.00
WHK-120BC 10 FT. WIRING HARNESS WITH BATTERY CLIP \$7.00



7870-101E-SB

DELAVAN	VOLTAGE	PORT SIZE	GPM	PSI	PRICE
2200-301	12VDC	3/8"HB	1.0	40	\$55.00
5850-201C	12VDC	1/2" F	5.3	45	\$185.00
7870-101E-SB (HIGHER CAPACITY)	12VDC	1/2" F	7.0	150	\$320.00

PTO ADAPTERS FOR HYPRO PUMPS

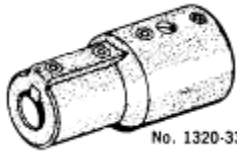

STANDARD ADAPTER ATTACHES TO TRACTOR SHAFT WITH SET SCREWS

1320-0022	STANDARD ADAPTER FOR SERIES 6500 PUMPS - FITS 5/8" SHAFT	\$31.98
1320-0076	STANDARD ADAPTER FOR ALL HYPRO SEVEN AND EIGHT ROLLER PUMPS - FITS 15/16" SHAFT	\$58.76
1320-0078	STANDARD ADAPTER FOR 1 3/8", 21 SPLINE, 1000 RPM. FITS 15/16" SHAFT ON 1500, 1700 AND 7560	\$56.16
1320-0080	STANDARD ADAPTER FOR 1 3/4", 21 SPLINE, 1000 RPM. FITS 15/16" SHAFT ON 1500, 1700 AND 7560.	\$82.16
1321-0006	QUICK COUPLER FOR SERIES 6500 PUMPS - FIT 5/8" PUMP SHAFT, 540 PTO SHAFT	\$59.54
1321-0007	QUICK COUPLER FOR ALL HYPRO SEVEN AND EIGHT ROLLER PUMPS - FITS 15/16" PUMPSHAFT, 540 PTO SHAFT.	\$64.48
1321-0012	MULTI-SPEED QUICK COUPLER FOR 6500, 4000 SERIES PUMP, FITS 1 3/8" 540 OR 1000 RPM PTO SHAFT, 5/8" PUMP SHAFT.	\$59.54
1321-0013	MULTI-SPEED QUICK COUPLER FOR 7560 AND 7700 PUMP, FITS 1 3/8" 540 OR 1000 RPM PTO SHAFT, 15/16" PUMP SHAFT.	\$63.44

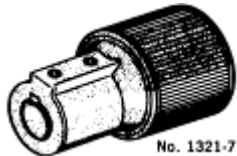

QUICK COUPLER ATTACHES TO TRACTOR SHAFT WITH SLIP COLLAR

SNAP HITCH PUMP ADAPTER

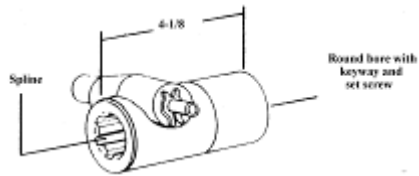

PART NO.	SPLINE SIZE	ROUND BORE	KEYWAY SIZE	PRICE
114-1000	1 3/8 x 6	5/8	3/16	\$67.14
114-1500	1 3/8 x 6	15/16	1/4	\$72.50
602PA	1 3/8 X 6	5/8	3-16	\$39.19
605PA	1 3/8 X 6	15/16	1/4	\$39.19



QUICK COUPLERS

QUICK COUPLERS PROVIDE QUICK AND SIMPLE ON-OFF INSTALLATION. THE BODY IS STEEL AND THE COLLAR IS DURABLE NYLON 12 THAT IS COLOR-CODED ACCORDING TO INTERNATIONAL SAFETY STANDARDS.

PART#	PTO	SHAFT	TOOTH	BODY	MAX RPM	PRICE
*90000	1 3/8"	5/8"	9-TOOTH	FORGED STEEL	540-1000 RPM	53.00
*90100	1 3/8"	15/16"	9-TOOTH	FORGED STEEL	540-1000 RPM	58.50
90400	1 3/8"	5/8"	21-TOOTH	FORGED STEEL	1000RPM	50.00
90500	1 3/8"	15/16"	21-TOOTH	FORGED STEEL	1000RPM	44.00
90600	1 3/8"	5/8"	6-TOOTH	FORGED STEEL	540 RPM	53.00
90700	1 3/8"	15/16"	6-TOOTH	FORGED STEEL	540 RPM	53.00
90800	1 3/4"	15/16"	20-TOOTH	FORGED STEEL	1000RPM	90.00

*MULTI-SPEED



HYPRO CENTRIFUGAL PUMPS

9000

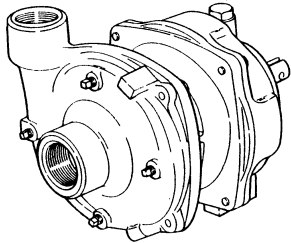

PLANETARY OIL-BATH GEAR-DRIVE

SERIES 9000 PUMPS
 PORT SIZES: 1 1/2" NPT INLET, 1 1/4" NPT OUTLET
 HOUSING: CAST IRON
 IMPELLER: NYLON
 PUMP SHAFT ROTATION: COUNTER CLOCKWISE
 WHEN LOOKING AT THE SHAFT END
 PUMP SEALS: VITON/CERAMIC STANDARD
 WEIGHT: 44 LBS

MODEL	RPM	SHAFT	PRICE
9006C-O	600	1 3/8" 6 SPLINE	\$1440.40
9008C-O	1000	1 3/8" 21 SPLINE	\$1530.88
9016C-O	600	1" SOLID	\$1422.72
9018C-O	1000	1" SOLID	\$1505.92
9028C-O	1000	1 3/4" 20 SPLINE	\$1776.32

9200

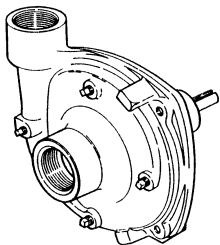

PEDESTAL MOUNTED

SERIES 9200
 AVAILABLE IN CAST IRON AND 316 SS
 PEDESTAL MOUNT, DIRECT DRIVE
 PORT SIZES: 1 1/4" NPT, 1" NPT OUTLET (9202)
 1 1/2" NPT INLET, 1 1/4" NPT OUTLET
 IMPELLER: NYLON (CI) POLY (SS)
 PUMP SHAFT ROTATION: COUNTER CLOCKWISE WHEN
 LOOKING AT THE SHAFT END
 PUMP SEALS: VITON/CERAMIC STANDARD
 WEIGHT: 18 LBS

MAX PSI: 170
 MAX RPM: 6000
 SHAFT: 5/8" SOLID

MODEL	PRICE
9202C	\$590.72
9203C	\$598.00

9300



SERIES 9300 CAST IRON HYDRAULIC MOTOR DRIVEN CENTRIFUGAL

9303C-HM1C, OPEN/CLOSED HYDRAULIC SYSTEM, MAX GPM: 114, MAX
 PSI:114 GPM HYDRAULIC MOTOR: 13 \$1326.00

9303C-HM2C, OPEN/CLOSED HYDRAULIC SYSTEM; MAX GPM: 97, MAX PSI: 95
 GPM HYDRAULIC MOTOR: 6 \$1326.00

9303C-HM3C, OPEN/CLOSED HYDRAULIC SYSTEM, MAX GPM:125, MAX PSI: 98
 GPM HYDRAULIC MOTOR: 24 \$1410.24

9303C-HM4C, OPEN/CLOSED HYDRAULIC SYSTEM, MAX GPM: 115, MAX
 PSI:93 GPM HYDRAULIC MOTOR: 7 \$1326.00

MOUNTING ALMOST ANYWHERE ON TRACTOR OR SPRAYER, SERIES 9300 BECOMES PART OF THE
 VEHICLES HYDRAULIC SYSTEM AND FREES THE PTO FOR OTHER USES. "CLOSE-COUPLED" DESIGN
 REDUCES MOUNTING SPACE - A SINGLE STAINLESS STEEL SHAFT IS COMMON TO BOTH PUMP AND
 MOTOR.

PUMP CONSTRUCTION: EPOXY -COATED CAST-IRON HOUSING, NYLON IMPELLER, TWO NEEDLE
 MAIN BEARINGS AND AN OUTBOARD, DOUBLE-SEALED FACTORY-LUBRICATED BALL BEARING. VITON
 SEALING ELEMENT STANDARD; BUNA-N OPTIONAL. 4-POSITION PUMP OUTLET, 1 1/4" TOP,
 1 1/2" SUCTION.

MOTOR CONSTRUCTION: FIXED DISPLACEMENT, SMOOTH RUNNING GEROTOR, INTERNAL GEAR
 DESIGN, TEFLON SHAFT SEAL, AND TWO NEEDLE BEARINGS AND A BALL BEARING TO SUPPORT THE
 MOTOR/PUMP SHAFT.

9306C-HM5C \$1538.16
 OPEN/CLOSED CENTER, MAX GPM 212, MAX PSI 140, MAX HYD. GPM 17,
 CAST IRON PUMP HYDRAULIC MOTOR
 FITS JD 4710 SPRAYERS SERIAL # 4001 AND ABOVE.
 4720, 4730, AND 4830 ALL SERIAL NUMBERS



CENTRIFUGAL PUMPS



THESE MODELS ARE CAST IRON STRAIGHT CENTRIFUGAL FRAME MOUNTED PUMPS DRIVEN BY A CLOSE COUPLED HYDRAULIC MOTOR. THE HYDRAULIC MOTORS HAVE TWO BUILT IN CHECK VALVES TO PREVENT SEAL DAMAGE DUE TO IMPELLER COASTING AND REVERSE ROTATION. EACH MOTOR ALSO HAS AN INTEGRAL NEEDLE VALVE TO BY-PASS EXCESS HYDRAULIC FLUID ON OPEN CENTER SYSTEMS. CONSULT THE **TRACTOR HYDRAULIC SYSTEM PUMP SELECTION GUIDE** TO MATCH THE CORRECT PUMP WITH THE APPLICATION.

	1 1/4" SUCTION x 1" DISCHARGE	
FMC-HYD-204	MAXIMUM PRESSURES 100 PSI AT 4600 RPM AND 75 GPM AT OPEN DISCHARGE. 4 GPM HYDRAULIC MOTOR CAN BE USED ON PRESSURE COMPENSATING CLOSED CENTER SYSTEMS (JOHN DEERE TYPE) OR OPEN CENTERED SYSTEMS RATED AT 4-13 GPM. EQUIPPED WITH RESTRICTOR ORIFICE. WT. 26 LBS.	\$1255.00
FMC-HYD-210	MAXIMUM PRESSURES 100 PSI AT 4600 RPM AND 75 GPM AT OPEN DISCHARGE. 10 GPM HYDRAULIC MOTOR CAN BE USED ON LOAD SENSING CLOSED CENTER SYSTEMS. (CASE IH TYPE) OR OPEN CENTERED SYSTEMS RATED 8-17 GPM. WT. 27 LBS.	\$1255.00
FMC-HYD-310	MAXIMUM PRESSURES 60 PSI AT 3950 RPM AND 60 GPM AT OPEN DISCHARGE. 16 GPM HYDRAULIC MOTOR CAN BE USED ON OPEN CENTER SYSTEMS RATED 16-24 GPM. WT. 33 LBS.	\$1280.00
	1 1/2" SUCTION x 1 1/4" DISCHARGE	150 SERIES HIGH PERFORMANCE
FMC-150-HYD-206	MAXIMUM PRESSURES 120 PSI AT 5100 RPM AND 120 GPM AT OPEN DISCHARGE. 7 GPM HYDRAULIC MOTOR CAN BE USED ON PRESSURE COMPENSATING CLOSED CENTER SYSTEMS (JOHN DEERE TYPE), LOAD SENSING CLOSED CENTER SYSTEMS (CASE-IH TYPE), AND OPEN SYSTEMS RATED 7-16 GPM. EQUIPPED WITH RESTRICTOR ORIFICE. WT. 31 LBS.	\$1285.00
FMC-SC150HYD206	SAME AS ABOVE EXCEPT HAS SEVERE DUTY SILICON CARBIDE SEAL.	\$1380.00
FMC-200-HYD-210	MAXIMUM PRESSURES 80 PSI AT 4400 RPM AND 180 GPM AT OPEN DISCHARGE. 210 MOTOR REQUIRES 10 GPM HYDRAULIC MOTOR FLUID INPUT. RECOMMENDED FOR: PRESSURE COMPENSATING CLOSED CENTER SYSTEMS, LOAD SENSING CLOSED CENTER SYSTEMS, OPEN CENTER SYSTEMS UP TO 17 GPM USING INTERNAL NEEDLE VALVE BYPASS. EQUIPPED WITH RESTRICTOR ORIFICE. WT. 33 LBS.	\$1510.00

FLOW LIMITER VALVE – FOR USE ON LOAD SENSING HYDRAULIC SYSTEMS

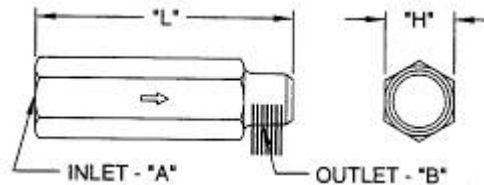

INSTALLS IN ACE HYDRAULIC MOTOR INLET PORT, SHUTS OFF ALL HYDRAULIC FLOW WHEN THE MOTOR'S CAPACITY IS EXCEEDED, PROTECTS MOTOR FROM OVERSPEEDING, AUTOMATICALLY RESETS WHEN HYDRAULIC PRESSURE IS RELEASED.

OLD SERIES 200 AND 300 SERIES MOTORS

MOTOR	PART#	A	B	L	H	PRICE
BAC-75-HYD-204	LS-204	3/8" NPT	3/8" NPT	3 1/4"	7/8"	77.00
BAC-75-HYD-206	41408	3/8" NPT	3/8" NPT	3 1/4"	7/8"	77.00
BAC-75-HYD-210	41411	3/8" NPT	3/8" NPT	3 1/4"	7/8"	77.00

NEW SERIES 200N AND 300A MOTORS

MOTOR	PART #	A	B	L	H	PRICE
BAC-75-HYD-204	41417(LS-204N)	1/2" NPT	#8 SAE	3 1/4"	1 1/8"	87.00
BAC-75-HYD-206	41418(LS-206N)	1/2" NPT	#8 SAE	3 1/4"	1 1/8"	87.00
BAC-75-HYD-210	41423(LS-210N)	1/2" NPT	#8 SAE	3 1/4"	1 1/8"	87.00
BAC-75-HYD-304	41413(LS-304)	1/2" NPT	1/2" NPT	3 5/16"	1 1/8"	87.00

DOWNDROPS AND SPECIAL 3 NOZZLE ASSEMBLIES

SPECIAL 3-NOZZLE ASSEMBLY

OVER-THE-ROW PLACEMENT OF SPRAY MATERIAL FOR CONTROL OF TOBACCO SUCKERS AND FOR APPLYING FUNGICIDE TO PEANUTS. TWO SINGLE SWIVEL NOZZLES AND ONE STRAIGHT NOZZLE COMPLETE WITH CAPS, STRAINERS, AND TIPS. USE ONE PER ROW.

RS-102 - FOR CONTACT SUCKER CONTROL - ONE BRASS TG-5 FULL CONE SPRAY TIP OVER CENTER OF ROW, ONE TG-3 FULL CONE SPRAY TIP EACH SIDE OF CENTER. \$83.35

RS-103 - FOR PEANUT FUNGICIDE SPRAYING - THREE D2-13 DISC TYPE HOLLOW CONE SPRAY TIPS OVER ROW \$70.86

RS-104 - 3-NOZZLE ASSEMBLY LESS, TIPS, CAPS AND STRAINERS \$53.58

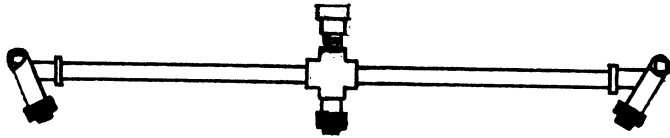

DOWNDROPS LESS NOZZLE PARTS

DOWNDROP FITTED WITH SWIVEL CAP CONNECTOR, 5" FLEXIBLE HOSE, 12" ALUMINUM PIPE WITH 1/4" MALE PIPE THREAD AT LOWER END. MAY BE USED WITH METERING ORIFICES FOR DRIBBLE APPLICATION OF SOLUTION FERTILIZERS OR MAY BE EQUIPPED WITH SWIVEL NOZZLES FOR ROW CROP SPRAYING. AVAILABLE IN BRASS OR NYLON SWIVEL CAPS.

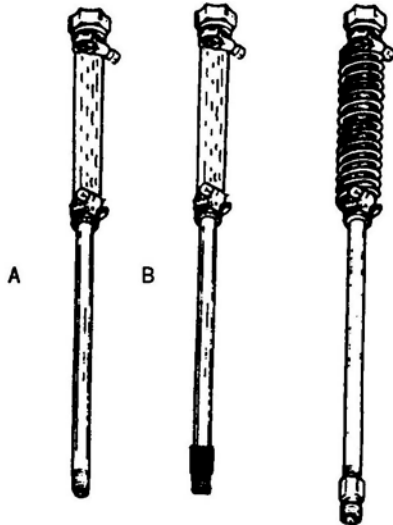

OPTIONAL:
DOWNDROP WITH
RS-199-10 SPRING
ADD: \$6.36

(A) DD5 BRASS CAP	\$22.06
(A) DD6 NYLON CAP	\$21.64
(B) DD7 NYLON CAP WITH NYLON BODY	\$28.23
QJ OPTION: TOPCAP	ADD \$.35
LOWER BODY	ADD \$ 1.35

TeeJet[®] DOWNDROPS

21353-6-15-NYB	QUICK TEEJET HOSE DROP WITH EPDM GASKET, 15"	\$14.29
21353-6-24-NYB	QUICK TEEJET HOSE DROP WITH EPDM GASKET, 24"	\$14.29
21354-15-NYB	TEEJET HOSE DROP NYLON THROUGHOUT, 15"	\$944
21354-24-NYB	TEEJET HOSE DROP NYLON THROUGHOUT, 24"	\$10.51

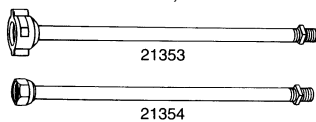

DOWNDROPS WITH SWIVEL NOZZLES

DOWNDROP IS FITTED WITH SWIVEL CAP CONNECTOR, 5" FLEXIBLE HOSE, 12" ALUMINUM PIPE WITH SINGLE OR DOUBLE SWIVEL NOZZLE ATTACHED. AVAILABLE WITH OR WITHOUT TIP, CAP, AND STRAINER TO COMPLETE NOZZLE ASSEMBLY. WHEN ORDERING TIP, CAP, AND STRAINER BE SURE TO SPECIFY TIP SIZE.

(A) 1DDNY
SINGLE NYLON SWIVEL WITH TIP, CAP, STRAINER \$41.07

(B) 2DDNY
SINGLE NYLON SWIVEL LESS TIP, CAP, STRAINER \$34.55

(C) 3DDNY
DOUBLE NYLON SWIVEL WITH TIP, CAP, STRAINER \$48.16

(D) 4DDNY
DOUBLE NYLON SWIVEL LESS, TIP, CAP, STRAINER \$36.16

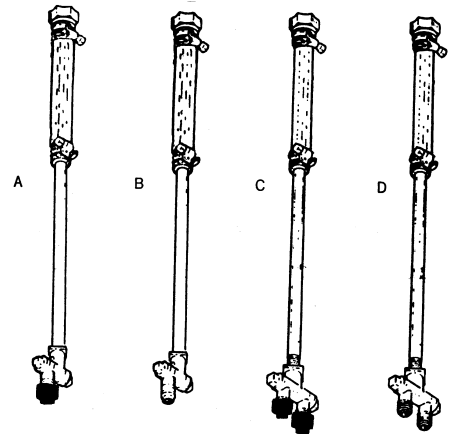

HEAVY DUTY DOWNDROPS

- FOR HIGH PRESSURE SPRAYING
- FOR BLUE MOLD CONTROL ON TOBACCO
- FOR FUNGICIDE APPLICATION ON TOMATOES
- TOTAL LENGTH 45"

K1-4	4 TIPS ON 1 SIDE	\$180.93
K2-4	4 TIPS ON EACH SIDE	\$202.12
K2-5	5 TIPS ON EACH SIDE	\$282.30

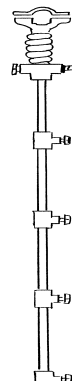

K1-4

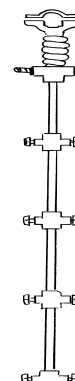

K2-4



NGP-6050 SERIES

NGP-6050 SERIES

SINGLE PISTON, DOUBLE ACTING	STROKE – VARIABLE
RATED FLOW – 21.0 GPM	INLET – 1 1/2" FPT
RATED PRESSURE – 120 PSI	OUTLET – 1 1/2" FPT
RATED SPEED – 450 RPM	CLUTCH – VARIOUS OPTIONS
RATED FLOW BASED ON 12 LB. PER GALLON FERTILIZER	SHAFT SIZE - 1"

MODELS AVAILABLE

NGP-6050	ROPE CONTROL CLUTCH	\$2544.55
NGP-6055(LM-2455)	WITHOUT CLUTCH	\$1958.65
NGP-6058	ELECTRIC CONTROL CLUTCH	\$2752.98
NGP-6059	HYDRAULIC CONTROL CLUTCH	\$2633.54



NGP-7050 SERIES

NGP-7050 SERIES

SINGLE PISTON, DOUBLE ACTING	STROKE – VARIABLE
RATED FLOW – 34.2 GPM	INLET – 1 1/2" FPT
RATED PRESSURE – 120 PSI	OUTLET – 1 1/2" FPT
RATED SPEED – 450 RPM	CLUTCH – VARIOUS OPTIONS
RATED FLOW BASED ON 12 LB. PER GALLON FERTILIZER	SHAFT SIZE - 1"

MODELS AVAILABLE

NGP-7050	ROPE CONTROL CLUTCH	\$2920.84
NGP-7055(LM-4455)	WITHOUT CLUTCH	\$2336.24
NGP-7058	ELECTRIC CONTROL CLUTCH	\$3121.81
NGP-7059	HYDRAULIC CONTROL CLUTCH	\$3075.49



NGP-9050 SERIES

NGP-9050 SERIES

DOUBLE PISTON, DOUBLE ACTING	STROKE – VARIABLE
RATED FLOW – 68.4 GPM	INLET – 1 1/2" FPT
RATED PRESSURE – 120 PSI	OUTLET – 1 1/2" FPT
RATED SPEED – 450 RPM	CLUTCH – VARIOUS OPTIONS
RATED FLOW BASED ON 12 LB. GALLON FERTILIZER	SHAFT SIZE - 1"

MODELS AVAILABLE

NGP-9050	ROPE CONTROL CLUTCH	\$3910.89
NGP-9055(LM-4955)	WITHOUT CLUTCH	\$3587.33
NGP-9058	ELECTRIC CONTROL CLUTCH	\$4224.80
NGP-9059	HYDRAULIC CONTROL CLUTCH	\$4193.28



NGP5655-ARF SERIES

APPLY TWO PRODUCTS AT TWO RATES WITH ONE PUMP

DOUBLE PISTON, DOUBLE ACTING	STROKE – VARIABLE
RATED FLOW – 31.2 GPM TOTAL	INLET/OUTLET SMALL 1" FPT
RATED SPEED – 450 RPM	INLET/OUTLET LARGE 1 1/2" FPT
10.2 GPM SMALL SIDE	21 GPM LARGE SIDE
CLUTCH – NO CLUTCH	

RATED FLOW BASED ON 12 LB. PER GALLON FERTILIZER

NGP-5655-ARF	\$3071.96
---------------------	------------------

JOHN BLUE PARTS

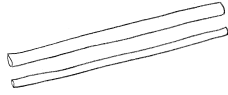

PUMP HOSE

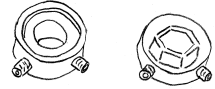

RETAINER ADAPTOR

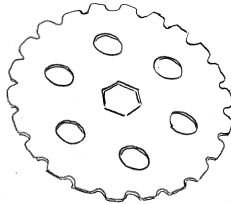

SPROCKET

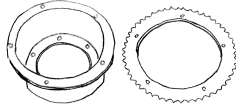
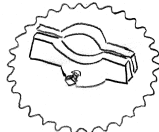

HUB ADAPTOR SPROCKET

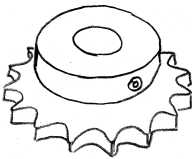

PUMP SPROCKET



IDLER SPOOL

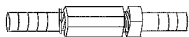

CHECK VALVE

SQUEEZE PUMP HOSE

PART NUMBER	DESCRIPTION	PRICE
L-1265	SQUEEZE PUMP HOSE KIT – 6 HOSE SET, 1/2" HOSE	45.07
87249	SQUEEZE PUMP HOSE – 1 HOSE, 1/2" HOSE	6.66
87250	SQUEEZE PUMP HOSE – 1 HOSE, 5/16" HOSE	6.66

PART NUMBER	DESCRIPTION	PRICE
L-1414	SPROCKET ADAPTOR – 7/8" BORE	38.09
L-1414-1	SPROCKET ADAPTOR – 1" BORE	38.09
L-1414-2	SPROCKET ADAPTOR – 3/8" BORE	35.01
L-4414	SPROCKET RETAINER – 7/8" BORE	29.29
L-4414-1	SPROCKET RETAINER – 1" BORE	30.09
L-4414-2	SPROCKET RETAINER – 3/8" BORE	29.29
112838	SPROCKET RETAINER – 7/8" HEX	40.99
112839	SPROCKET ADAPTOR – 7/8" HEX	34.58

PART NUMBER	DESCRIPTION	PRICE
L-1383	8 TOOTH SPROCKET	15.60
L-1384	9 TOOTH SPROCKET	24.21
L-1385	10 TOOTH SPROCKET	12.82
L-1386	15 TOOTH SPROCKET	23.38
L-1381	20 TOOTH SPROCKET	38.22
L-1387	22 TOOTH SPROCKET	35.47
L-1388	23 TOOTH SPROCKET	34.05
L-1389	26 TOOTH SPROCKET	37.74
L-1390	30 TOOTH SPROCKET	53.87
L-1391	31 TOOTH SPROCKET	55.88
L-1392	32 TOOTH SPROCKET	46.66
A-2040	SQUEEZE PUMP CHAIN – 10 FT BOX(USE W/ABOVE SPROCKET)	24.30

PART NUMBER	DESCRIPTION	PRICE
114936-91	SPROCKET – 32 TOOTH, RC 40 SPLIT FOR 7/8 HEX	97.92
114565-91	SPROCKET – 35 TOOTH, RC 40 SPLIT FOR 7/8 HEX	62.49

PART NUMBER	DESCRIPTION	PRICE
LA-1341-HA	HUB SPROCKET ADAPTOR – 4 BOLT	162.41
106190-01	HUB SPROCKET ADAPTOR – 5 BOLT	156.46
A-1341-HA	HUB SPROCKET ADAPTOR – 6 BOLT	158.21
A-1342-BP	50 TOOTH ROLLER CHAIN SPROCKET (50)	82.96
A-1342-AP	60 TOOTH ROLLER CHAIN SPROCKET (50)	102.45
A-1502	80 TOOTH ROLLER CHAIN SPROCKET (50)	140.09
107599-01	CONE SPACER TO USE WITH HUB ADAPTOR	12.78

SPROCKETS FOR PUMPS WITHOUT A CLUTCH

PART NUMBER	DESCRIPTION	PRICE
113611-01	11 TOOTH SPROCKET – RC 50, 1" BORE	45.10
114516-01	12 TOOTH SPROCKET – RC 40, 1" BORE	32.14
114677-01	14 TOOTH SPROCKET - RC 50, 1" BORE	37.81
113685-01	16 TOOTH SPROCKET – RC 50, 1" BORE	36.81
113905-01	18 TOOTH SPROCKET – RC 40, 1" BORE	37.93
106532-01	18 TOOTH SPROCKET – RC 50, 1" BORE	43.82
114517-01	23 TOOTH SPROCKET – RC 40, 1" BORE	87.26
112773	24 TOOTH SPROCKET – RC 50, 1" BORE	67.98
105482-01	32 TOOTH SPROCKET – RC 50, 1" BORE	95.40
112774	36 TOOTH SPROCKET – RC 50, 1" BORE	131.49
115156-01	18 TOOTH SPROCKET – RC 40, 7/8" HEX	54.33
115157-01	18 TOOTH SPROCKET – RC 50, 7/8" HEX	81.01
#40	#40 ROLLER CHAIN – 10 FT BOX	23.72
#50-10/BOX	GROUND DRIVE CHAIN – 10 FT BOX	38.00
A-401	IDLER SPOOL	24.96

CHECK VALVES

PART NUMBER	DESCRIPTION	PRICE
NS-3035	CHECK VALVE – NYLON, IN-LINE - 3/8" HOSE X 3/8" HOSE-8 PSI	26.71
113827	CHECK VALVE – STAINLESS BODY, NYLON BARBS, 1/2" HOSE - 8 PSI	37.54
113827-38	CHECK VALVE - STAINLESS BODY, NYLON BARBS, 3/8" HOSE - 8 PSI	37.54
CV-1101-B38	CHECK VALVE -GRAY PVC BODY, PVC HOSE BARBS, 3/8" HOSE - 1 PSI	13.78

DIAPHRAGM PUMPS



Model 9910-D70



Model 9910-D250

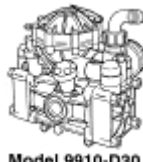

Model 9910-D30



Model 9910-D503



Model 9910-D50

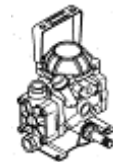

MODEL 9910-D252



LOW PRESSURE DIAPHRAGM PUMPS

MODEL NO.	MAX. GPM	MAX. PSI	MAX. RPM	DESCRIPTION	PRICE
9910-D70	19	290	550	2 - DIAPHRAGM PUMP 1 1/4" HB INLET, 1" HB OUTLET SELECT SHAFT KIT FOR DESIRED DRIVE	1272.33
9910-D250	66	290	550	6 - DIAPHRAGM PUMP 2" HB INLET, 1 1/2" HB OUTLET 1 3/8" 6 SPLINED MALE SHAFT	4264.22
9910-D252GRGI	5.3	363	3600	2 - DIAPHRAGM (SEMI-HYDRAULIC) PUMP - 3/4" HB INLET; 3/8" HB OUTLET. D252 - 3/4" HOLLOW SHAFT, GEAR REDUCED FOR 3 HP GAS ENGINE	1269.32

MEDIUM PRESSURE DIAPHRAGM PUMPS

MODEL NO.	MAX. GPM	MAX. PSI	MAX. RPM	DESCRIPTION	PRICE
9910-D30	9.5	580	550	2- DIAPHRAGM PUMP 1" HB INLET, 1/2" HB OUTLET SELECT SHAFT KIT OR GEAR REDUCTION	1146.71
9910-D30GRGI	9.0	580	3600	2-DIAPHRAGM PUMP W/GEAR REDUCTION 9910-KIT-1640	2056.23
9910-D50	14.0	580	550	2 - DIAPHRAGM PUMP 1 1/4" HB INLET, 1/2" HB OUTLET SELECT SHAFT KIT OR GEAR REDUCTION	1624.08
9910-D503	15.0	580	550	3 - DIAPHRAGM PUMP 1 1/4" HB INLET, 3/4" NPT OUTLET SELECT SHAFT KIT OR GEARBOX	1624.08

GEAR REDUCTION KITS

MODEL NUMBER	DESCRIPTION	PRICE
 9910-KIT1640	FOR MODEL 9910-D30, D303 AND D403 PUMPS 6:1 GEAR BOX FOR STANDARD 5 HP GAS ENGINE WITH 3/4" SHAFT (SEE BLUE SECTION FOR REPAIR PARTS)	772.85
 9910-KIT1642	FOR MODELS 9910-D50, D503, D813, D1064 AND D1265 PUMPS 6:1 GEAR BOX FOR STANDARD 8-18 HP GAS ENGINE WITH 1" SHAFT (SEE BLUE SECTION FOR REPAIR PARTS)	964.80

1 3/8" 6 SPLINE FEMALE PTO SHAFT KITS

MODEL NUMBER	DESCRIPTION	PRICE
 9910-KIT1704	FOR MODEL 9910-D50, D30, D303 AND D403 PUMPS	326.63

*KITS INCLUDE FEMALE PTO COUPLER AND RETAINING CLAMP, TORQUE ARM AND MOUNTING BRACKET, CHAINS AND NECESSARY HARDWARE.

1 3/8" 6 SPLINE MALE PTO SHAFT KITS

MODEL NUMBER	DESCRIPTION	PRICE
 9910-KIT1702	FOR MODEL 9910-D30	195.98
9910-KIT1706	FOR MODEL 9910-D50 PUMP	243.21
9910-KIT2200	FOR MODEL 9910-D503, D303 AND D403 PUMPS	176.88

*KITS INCLUDE MALE PTO SHAFT ADAPTER, MOUNTING BRACKET, AND NECESSARY HARDWARE.

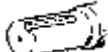

1" SOLID SHAFT KITS

MODEL NUMBER	DESCRIPTION	PRICE
 9910-KIT1711	FOR MODEL 9910-D70 & MODEL 9910-D115 PUMPS	342.71
9910-KIT2202	FOR MODEL 9910-D503, D303 AND D403 PUMPS	176.88

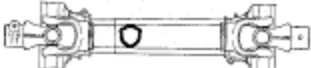





*KITS INCLUDE SOLID SHAFT ADAPTER, MOUNTING BRACKET, AND NECESSARY HARDWARE.

PART NO	PTO ASSEMBLY	PRICE
 89799	SPLINE SHAFT 1 3/8-6 SPLINE EACH END	161.35

CONTROL UNITS

MODEL NO.	MAX. GPM	MAX PSI	DESCRIPTION	PRICE
 9910-GS40GI	21	580	CONTROL UNIT FOR MOUNTING ON MODEL 9910-D30 AND D50 PUMPS. INCLUDES HIGH PRESSURE RELIEF VALVE AND TWO 1/2" HB OUTLETS WITH INDIVIDUAL SHUT-OFFS.	332.66
9910-KIT1741			REMOTE MOUNTING KIT FOR 9910-GS40GI OR 9910-DGR40 CONTROL UNIT.	72.36
 9910-GS50GI	48	725	REMOTE CONTROL UNIT FOR MODELS 9910-D813, D1064, D1265, D1516 AND D1554 PUMPS. INCLUDES HIGH PRESSURE RELIEF VALVE AND THREE 1/2" HB OUTLETS WITH INDIVIDUAL SHUT-OFFS	648.23
9910-KIT1742			REMOTE MOUNTING KIT FOR 9910-GS50GI CONTROL UNIT.	126.63

UDOR FLOW AND PRESSURE CONTROLS

MODEL	MAX. GPM	MAX.P SI	DESCRIPTION	PRICE
 SB-3	32	300	REMOTE-MOUNTED CONTROL VALVE PROVIDES THREE SECTION SPRAY BOOM CONTROL WITH MASTER ON/OFF VALVE. FEATURES 3/4" HB INLET AND 1/2" HB OUTLET PORTS. OPTIONAL 3/4" HB OUTLET PORTS ARE ALSO AVAILABLE. ORDER PART NO. 1406.26. USE WITH RO-70, RO-110, AND RO-121 OR SIMILAR PUMPS. (SHIPPING WEIGHT 6 LBS)	597.19
 6004.05	32	600	REMOTE MOUNTED CONTROL WITH ADJUSTABLE PRESSURE REGULATOR & MASTER ON/OFF LEVER, 3/4" HB INLET, 1" HB BYPASS, TWO 1/2" BALL VALVE DISCHARGE PORTS & TWO 3/8" FEMALE ACCESSORY PORTS.	507.17
 6005.15	45	1000	HIGH VOLUME ADJUSTABLE BRASS PRESSURE REGULATOR WITH MASTER ON/OFF LEVER, 3/4" MALE BSP INLET PORT, 1/4" GAUGE PORT & 1" HB BYPASS PORT.	406.44
 6005.31-N	26	600	PRESSURE REGULATOR WITH MANUAL DUMP LEVER, 1/4" GAUGE PORT, 3/4" MALE NPT INLET PORT & 3/4" HB BYPASS PORT.	215.89
6005.31/LP-N	26	350	PRESSURE REGULATOR WITH MANUAL DUMP LEVER, 1/4" GAUGE PORT, 3/4" MALE NPT INLET PORT & 3/4" HB BYPASS PORT.	215.89
 6010.24	20	560	PUMP OR REMOTE MOUNTED CONTROL WITH ADJUSTABLE PRESSURE REGULATOR WITH MANUAL DUMP LEVER. INCLUDES TWO 1/2" BALL VALVE DISCHARGE PORTS AND PRESSURE GAUGE. CONTROL IS STANDARD ON KAPPA-40/55.	246.48
 6047.06	26	560	PUMP OR REMOTE MOUNTED CONTROL WITH RIGHT ANGLE ENTRY FROM MAIN BODY TO ADJUSTABLE PRESSURE REGULATOR FOR SMOOTHER OPERATION AND LONGER LIFE. INCLUDES MANUAL DUMP LEVER, TWO 1/2" BALL VALVE DISCHARGE PORTS AND PRESSURE GAUGE. STANDARD ON KAPPA-75 & KAPPA 100	320.54

UDOR DIAPHRAGM PUMPS

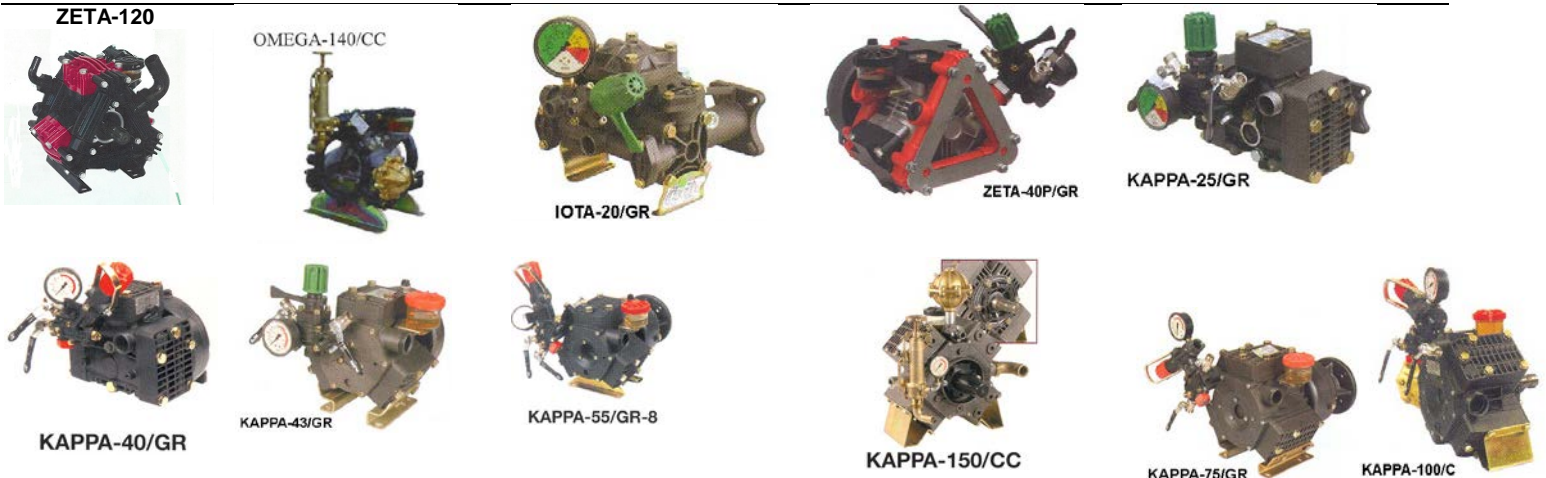

MODEL NO.	MAX. GPM	MAX. PSI	DESCRIPTION	HOSE PORT IN	BARB OUT	RELIEF BYPASS	PRICE
IOTA-20/GR	5.0	275	PUMP WITH A GEAR REDUCTION FOR 3-5 HP GASOLINE ENGINES WITH 3/4" SHAFTS. WT. 17 LBS	3/4"	3/8"	5/8"	1050.60
ZETA-170/C	45	300	FOUR DIAPHRAGM PUMP WITH PULSATION DAMPENER, MOUNTING RAILS AND A 1-3/8", SIX SPLINE MALE PTO SHAFT. WT. 56 LBS.	1 1/2"	1"		2590.45
ZETA-120/GR	31	290	THREE DIAPHRAGM PUMP WITH GEAR REDUCTION FOR USE ON 8-11 HP GASOLINE ENGINES WITH 1" SHAFTS. WT. 63 LBS.	1 1/2"	3/4"		2384.45
ZETA-40P/GR	10.5	300	THREE DIAPHRAGM POLY PUMP WITH CONTROL UNIT WITH ADJUSTABLE PRESSURE REGULATOR, MANUAL DUMP LEVER, DUAL BALL VALVE OUTLETS AND PRESSURE GAUGE. FITTED WITH GEAR BOX FOR 4-6.5 HP GASOLINE ENGINES WITH 3/4" SHAFTS. WT. 46 LBS.	1 1/4"	(2) 1/2"	3/4"	2616.20
KAPPA-25/GR	7.0	350	TWO DIAPHRAGM PUMP WITH PULSATION DAMPENER AND CONTROL UNIT WITH ADJUSTABLE PRESSURE REGULATOR, MANUAL DUMP LEVER, DUAL BALL VALVE OUTLETS AND PRESSURE GAUGE. EQUIPPED WITH A GEARBOX FOR 3-5.5 HP GASOLINE ENGINES WITH 3/4" SHAFTS. WT. 28 LBS.	1"	(2) 1/2"	3/4"	1184.50
DELTA-40/GR	10.5	560	PUMP WITH GEAR REDUCTION FOR 4-6.5 HP GASOLINE ENGINES WITH 3/4" SHAFTS. WT. 39 LBS	1"	(2) 1/2"	3/4"	1735.55
KAPPA-43/GR	10.5	560	THREE DIAPHRAGM PUMP WITH CONTROL UNIT WITH ADJUSTABLE PRESSURE REGULATOR, MANUAL DUMP LEVER, DUAL BALL VALVE OUTLETS AND PRESSURE GAUGE. FITTED WITH GEARBOX FOR 4-6.5 HP GASOLINE ENGINES WITH 3/4" SHAFTS. WT. 39 LBS.	1"	(2) 1/2"	3/4"	1735.55
KAPPA-55/GR-8	15	560	PUMP WITH GEAR REDUCTION FOR 8-9 HP GASOLINE ENGINES WITH 1" SHAFTS. WT. 49 LBS	1 1/4"	(2) 1/2"	3/4"	2255.70
KAPPA-55/WOC	15	560	THREE DIAPHRAGM PUMP WITH UNIVERSAL DRIVE FACE, PULATION DAMPENER. REQUIRES SHAFT KIT AND CONTROL. USED ON VEGETABLE SPRAYER. WT. 37 LBS.	1 1/4"	(2) 1/2"	3/4"	1339.00
DELTA-75/WOC	20	560	PUMP WITH GEAR REDUCTION FOR 9-13 HP GASOLINE ENGINES WITH 1" SHAFTS. WT 58 LBS.	1 1/4"	(2) 1/2"	3/4"	1714.95
KAPPA-100/C	26	560	FOUR DIAPHRAGM PUMP WITH PULSATION DAMPENER AND CONTROL UNIT WITH ADJUSTABLE PRESSURE REGULATOR, MANUAL DUMP LEVER, DUAL BALL VALVE OUTLETS. WT. 52 LBS.	1 1/2"	(2) 1/2"	3/4"	2255.70
KAPPA-150/CC	40	700	FOUR DIAPHRAGM PUMP WITH PULSATION DAMPENER AND CONTROL UNIT WITH ADJUSTABLE PRESSURE REGULATOR, MANUAL DUMP LEVER AND PRESSURE GAUGE. HAS DUAL 1 3/8", 6-SPLINE MALE PTO SHAFT. WT. 105 LBS	1 1/2"	(1) 3/4" MALE NPT (1) 3/4" FEMALE NPT	1"	4202.40
OMEGA-140/CC	39	700	THREE DIAPHRAGM PUMP WITH PULSATION DAMPENER & CONTROL UNIT WITH ADJUSTABLE PRESSURE REGULATOR, MANUAL DUMP LEVER, DUAL BALL VALVE OUTLETS & PRESSURE GAUGE WT. 100 LBS.	1 1/2"	(2) 1/2" (2) 3/4" FEMALE NPT	1"	3625.60
OMEGA-170/CC	39	700	FOUR DIAPHRAGM PUMP WITH PULSATION DAMPENER & CONTROL UNIT WITH ADJUSTABLE PRESSURE REGULATOR, MANUAL DUMP LEVER, DUAL BALL VALVE OUTLETS & PRESSURE GAUGE. HAS DUAL 1 3/8" 6-SPLINE MALE PTO SHAFT	1 1/2"	(2) 1/2" (2) 3/4" FEMALE NPT	1"	4207.55

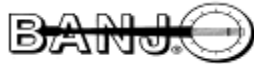

CENTRIFUGAL TRANSFER PUMPS

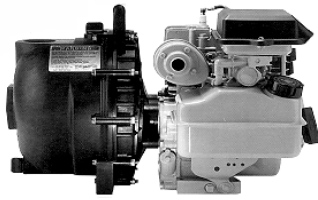

GAS ENGINE POLYPROPYLENE PUMPS

200P6PRO	2" x 2" PUMP WITH 6.5 H.P. BRIGGS PRO SERIES ENGINE	\$493.70
200PH-5	2" X2" PUMP WITH 5.5 H.P. HONDA GAS ENGINE MAXIMUM LIFT – 15 FT.	\$929.20

POLYPROPYLENE PUMPS ONLY

150PO	1 1/2" x 1 1/2" PUMP ONLY UNASSEMBLED(3 VANE IMPELLER)	\$389.47
205PO	2" x 2" PUMP ONLY UNASSEMBLED(5 VANE IMPELLER)	\$389.47



GAS ENGINE DRIVEN CAST IRON PUMPS

150PI-3	1 1/2" x 1 1/2" PUMP WITH 3.5 H.P. BRIGGS & STRATTON ENGINE	\$800.98
200PI6PRO	2" x 2" PUMP WITH 6.5 H.P. BRIGGS PRO SERIES	\$756.05
200PIH-5	2" X 2" PUMP WITH 5.5 H.P. HONDA ENGINE	\$1221.15

CAST IRON PUMPS ONLY

150POI	1 1/2" x 1 1/2" PUMP ONLY	\$463.82
200POI	2" x 2" PUMP ONLY	\$489.45
300POI	3" x 3" PUMP ONLY	\$1065.48



BEARING PEDESTAL MOUNTED CAST IRON PUMPS

150PBI	1 1/2" PUMP/BEARING PEDESTAL 3/4" SHAFT	\$463.82
200PBI	2" PUMP/BEARING PEDESTAL 3/4" SHAFT	\$633.34
300PBI	3" PUMP BEARING PEDESTAL 1" SHAFT USE FLEXIBLE COUPLINGS TO EASILY ADAPT THIS PUMP TO GAS ENGINE OR ELECTRIC MOTOR	\$1241.50

CENTRIFUGAL PRESSURE PUMPS

ACE PUMPS



GE-85-HONDA

GE-85-HONDA	- GE-85 PUMP MOUNTED ON 4 HP HONDA. MAXIMUM PRESSURE: 57 PSI, MAXIMUM FLOW: 22.5 GPM. WT. 31 LBS.	\$1300.00
-------------	--	-----------

GE-85-LE	- POLYPROPYLENE CENTRIFUGAL PUMP LESS ENGINE. MOUNTS DIRECTLY ON 3/4" KEYED ENGINE SHAFT. MAXIMUM PRESSURE: 57 PSI, MAXIMUM FLOW: 22.5 GPM. WT. 5 LBS.	\$318.00
----------	--	----------



GE-660

GE-660-LE	- CAST IRON CENTRIFUGAL PUMP LESS ENGINE. MOUNTS DIRECTLY ON 3/4 KEYED ENGINE SHAFT. GPM: 110, PSI: 120, WT 20 LBS.	\$644.00
-----------	--	----------

GE-660-BRIGGS	- GE-660 PUMP MOUNTED ON 5.5 HP BRIGGS & STRATTON. WT. 60 LBS. 1 1/2 SUCTION X 1 1/4 DISCHARGE, 110 GPM, 120 PSI	\$1900.00
---------------	---	-----------

GE-660-HONDA	- GE-660 PUMP MOUNTED ON 5.5 HP HONDA. WT. 60 LBS. 1 1/2 SUCTION X 1 1/4 DISCHARGE, 110 GPM, 120 PSI	\$2140.00
--------------	---	-----------

HYPRO PUMPS



1536	- 1 1/2" X 1 1/4" CENTRIFUGAL PUMP WITH BRIGGS AND STRATON 5 HP GAS ENGINE WITH MOUNTING BASE. GPM: 110, MAXIMUM PSI: 75. WT. 53 LBS.	\$1511.12
------	--	-----------

1537	1 1/2 X 1 1/4 CENTRIFUGAL PUMP WITH 5.5 HP HONDA GAS ENGINE WITH MOUNTING BASE. GPM: 110, MAXIMUM PSI: 80, WT 53 LBS.	\$2307.76
------	--	-----------

**ACCESSORIES
REPLACEMENT ENGINE**

HP	MODEL	DESCRIPTION - HONDA	CRANKSHAFT	PRICE
4	GX120UT2QX2	MANUAL START - OIL ALERT	3/4"	363.00
5.5	GX160UT2QX2	MANUAL START - OIL ALERT	3/4"	393.00
5.5	GX160UT2QXE2	ELECTRIC START - OIL ALERT	3/4"	599.00
6.5	GX200UT2QX2	MANUAL START - OIL ALERT	3/4"	417.00
6.5	GX200UT2QXE2	ELECTRIC START - OIL ALERT	3/4"	661.00
9	GX270UT2QA2	MANUAL START - OIL ALERT	1"	650.00
9	GX270UT2QAE2	ELECTRIC START - OIL ALERT	1"	853.00
11	GX340UT2QA2	MANUAL START - OIL ALERT	1"	688.00
11	GX340UT2QAE2	ELECTRIC START	1"	916.00
13	GX390UT2QAE2	ELECTRIC START	1"	930.00

FLEXIBLE COUPLINGS

ONE COMPLETE COUPLING IS MADE UP FROM TWO HALVES AND ONE INSERT

PART #	INSERT	PRICE	PART#	COUPLING	BORE	PRICE
234-0300	#3	12.30	233-0308	#3	1/2"	52.00
234-0400	#4	14.36	233-0310	#3	5/8"	33.75
			233-0312	#3	3/4"	33.75
			233-0314	#3	7/8"	52.00

HORSEPOWER RATINGS

INSERT#	870 RPM	1150 RPM	1750 RPM	3500 RPM
3	3.70	4.89	7.45	14.9
4	9.64	12.75	19.4	

UNIFORM SERVICE FACTOR = 1.0

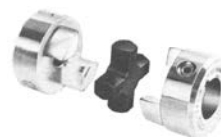

PART#	DESCRIPTION	PRICE
FV-112	1 1/2" FOOT VALVE	34.90
FV-200	2" FOOT VALVE	56.70



PART#	DESCRIPTION	PRICE
RS-112	1 1/2" STRAINER	14.60
RS-200	2" STRAINER	19.15



PART #	DESCRIPTION	PRICE
150SBS	1 1/2" SUCTION BASKET	21.95
200SBS	2" SUCTION BASKET	23.40



STEEL COMBINATION NIPPLES-PLATED

PART#	SIZE	PRICE
CNSP-012	1/2"	2.25
CNSP-034	3/4"	1.90
CNSP-100	1"	3.20
CNSP-114	1 1/4"	3.15
CNSP-112	1 1/2"	4.35
CNSP-200	2"	5.65



FIRE NOZZLES

PART#	SIZE	THREAD	PRICE
FNB75GHT	3/4"	GHT	33.75
FNB100S	1"	NPS	67.60
FNB150S	1 1/2"	NPS	71.45

QUICK TEEJET CAPS FOR PRESSURES UP TO 300 PSI

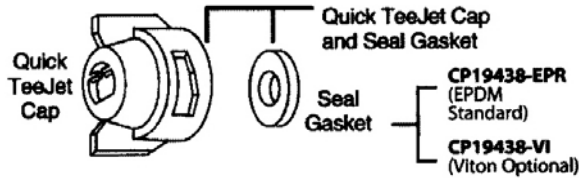



















COLORS OF QUICK TEEJET CAPS	COLOR CODE	COLORS OF QUICK TEEJET CAPS	COLOR CODE
BLACK	1	GREEN	5
WHITE	2	YELLOW	6
RED	3	BROWN	7
BLUE	4	ORANGE	8
		PURPLE	10





*BE SURE TO SPECIFY COLOR CODE.
PURPLE (10) ONLY AVAILABLE IN CP25611 AND CP25597 NYLON CAPS

PART NUMBERS FOR USE WITH SPRAY TIPS - 300 PSI MAXIMUM PRESSURE

	CAP ONLY	CAP/GASKET SET	
	CP114440-*-CE \$0.89	114441-*-CELR \$1.25	TeeJet® Flat Spray Tips (Smaller Capacities) Standard -0067 to -08 XR -01 to -08 Turbo TwinJet* AIXR TeeJet* DG TeeJet* Turbo TeeJet* OC TeeJet*
	CP25609-*-NY \$1.02	25610-*-NYR \$1.42	TeeJet® Flat Spray Tips (Larger Capacities) Standard -10 to -20 XR -10 to -15
Fits Hardi	CP58350-*-CE \$0.92	58348H-*-CELR \$1.47	TK FloodJet* TX ConeJet* Standard -0067 to -08
	CP114442-*-CE \$1.02	114443-*-CELR \$1.42	TJ TwinJet* AI Turbo TwinJet* DG TwinJet* SJ-3 StreamJet* AI TeeJet* & AIUB TeeJet* Turbo TeeJet* Induction
	CP25599-*-NY \$1.02	25600-*-NYR \$1.42	Turbo FloodJet* TK-VP FloodJet* TK-VS FloodJet* Locating Nib
	CP114444-*-CE \$1.02	114445-*-CELR \$1.42	TG Full Cone Hose Shank AITXA TK FloodJet* FL FullJet* TX ConeJet*
	CP114444-*-CE \$1.02		Disc Core CP18999-EPR Disc-Core Sprays (insert Core into Seal)
	CP26277-1-NY \$1.02	26278-1-NYR \$1.54	Disc Core Ceramic Disc-Core
	\$2.82 \$2.82	QJ4676-1/8-NYR QJ4676-1/4-NYR	QUICK TEEJET ADAPTER CAP WITH EPDM GASKET - 1/8" QUICK TEEJET ADAPTER CAP WITH EPDM GASKET - 1/4"
	\$5.36 \$5.36	QJ4676-90-1/4-NYR QJ4676-45-1/4-NYR	QUICK TEEJET ADAPTER CAP 1/4TTJ WITH EPDM SEAT GASKET- 90 DEGREE QUICK TEEJET ADAPTER CAP 1/4TTJ WITH EPDM SEAT GASKET - 45 DEGREE
QJ90-2 QJ90-1	\$5.36 \$5.36	QJ90-1-NYR QJ90-2-NYR	90 DEGREE QUICK TEEJET ADAPTER WITH EPDM GASKET QUICK TEEJET DUO NOZZLE ADAPTER WITH EPDM GASKET
	\$2.70	114447-1-CELR	QUICK TEEJET SHUT OFF CAP WITH GASKET PROVIDES SHUTOFF AT NOZZLE FOR QUICK SPACING CHANGE OR CHANGE IN SPRAY SWATH.
	CP19438-EPR \$0.61	CP19438-VI \$2.53	QUICK TEEJET GASKET, EPDM QUICK TEEJET GASKET, VITON
	CP18999-EPR \$1.32	CP18999-VI \$8.02	QUICK TEEJET GASKET, FOR DISC-CORE TYPE SPRAY TIPS, EPDM QUICK TEEJET GASKET, FOR DISC-CORE TYPE SPRAY TIPS, VITON

TEEJET SPRAY TIPS

	TYPE	SIZE	BODY MATERIAL	EXAMPLE TIP NO.	PRICE
	XR EXTENDED RANGE (TAPERED FLAT SPRAY) VISIFLO COLOR CODED	-01 THRU 15	STAINLESS STEEL HARD. STAINLESS/CELCON POLYMER (110 only)	XR8010SS XR8001VS XR11002-VP	9.91 8.35 3.76
	XRC EXTENDED RANGE (TAPERED FLAT SPRAY) VISIFLO COLOR CODED	ALL SIZES	STAINLESS STEEL	XRC11004-VS	9.59
	DG DRIFT GUARD (TAPERED FLAT SPRAY) VISIFLO COLOR-CODED	-01 THRU -05	STAINLESS STEEL/CELCON	DG8002VS	11.56
	TT TURBO (TAPERED FLAT FAN SPRAY) VISIFLO COLOR CODED	ALL SIZES	POLYMER (110 DEGREE ONLY)	TT11001-VP	7.87
	TTI -TURBO INJECTION 110 DEGREE WIDE ANGLE, AIR INDUCTION	ALL SIZES	POLYMER	TTI11002-VP	13.48
	TTJ60 -TURBO TWINJET 110 DEGREE DUAL OUTLET	-02 THRU 06	POLYMER	TTJ60-11002VP	9.44
	TP (TAPERED FLAT SPRAY) VISIFLO COLOR CODED	-01 AND LARGER -01 AND LARGER -01 AND LARGER -015 AND LARGER	BRASS STAINLESS STEEL STAINLESS STEEL/CELCON POLYMER	TP8001 TP11001-SS TP11001VS TP8002VP	5.02 12.86 7.47 1.08
	TP-E (EVEN FLAT SPRAY) VISIFLO COLOR-CODED	-01 AND LARGER -01 AND LARGER	BRASS STAINLESS STEEL STAINLESS STEEL/CELCON	TP8001E TP8001E-SS TP8001EVS	5.10 13.09 7.47
	TJ60 (TWIN TAPERED FLAT SPRAY) VISIFLO COLOR-CODED	ALL SIZES	STAINLESS STEEL/CELCON	TJ60-8003VS	14.53
	TJ60-E (TWIN EVEN FLAT SPRAY) VISIFLO COLOR-CODED	ALL SIZES	STAINLESS STEEL/CELCON	TJ60-8003EVS	20.25
	QJ90 -TURBO DUO TWO TURBO TEEJET FLAT FAN TIPS USING A QJ90-2-NYR	ALL SIZES	POLYMER	QJ90-2XTT11002-VP	23.39
	OC (OFF-CENTER - FLAT SPRAY)	-01 THRU -08, -12, -16	BRASS STAINLESS STEEL	OC-02 OC-SS02	13.34 19.72
	TF-VS TURBO FLOODJET (WIDE ANGLE FLAT SPRAY) VISIFLO COLOR CODED	ALL SIZES	STAINLESS STEEL/CELCON POLYMER	TF-VS4 TF-VP4	15.79 3.59
	TK FLOODJET (WIDE ANGLE FLAT SPRAY) VISIFLO COLOR-CODED	ALL SIZES	BRASS STAINLESS STEEL STAINLESS STEEL/CELCON	TK-3 TK-SS3 TK-VS3	8.22 14.96 14.24
	TG FULLJET (FULL CONE SPRAY)	1 AND LARGER	BRASS STAINLESS STEEL	TG-1 TG-SS1	10.87 23.96
	TX CONEJET (HOLLOW CONE SPRAY) VISIFLO COLORED CODED	ALL SIZES	BRASS STAINLESS STEEL STAINLESS STEEL CERAMIC	TX-1 TX-SS1 TX-VS4 TX-VK4	7.05 44.18 7.88 7.13
	AIXR - AIR INDUCTION XR FLAT (100 DEGREE WIDE, TAPERED FLAT SPRAY) VISIFLO COLOR-CODED	-015 THRU -06	UHMWPE POLYMER	AIXR11004VP	8.70
	AI TURBO TWINJET TWIN TAPERED FLAT FAN VISIFLO COLOR-CODED	ALL SIZES	POLYMER	AITTJ60-11004VP	9.80
	DG TWINJET DRIFT GUARD TWINJET (TWIN TAPERED FLAT FAN SPRAY) VISIFLO COLOR-CODED	ALL SIZES	STAINLESS STEEL/ ACETAL	DGTJ60-11004VS	17.72

	TYPE	SIZE	BODY MATERIAL	EXAMPLE TIP NO.	PRICE
	TURBO TURFJET SPRAY TIPS (WIDE ANGLE FLAT SPRAY) VISIFLO COLOR CODED	-02 THRU -15	STAINLESS STEEL/CELCON	1/4TTJ05-VS	20.46
	AIC TEEJET AIR INDUCTION (TAPERED FLAT SPRAY) VISIFLO COLOR-CODED	05 THRU 10	CELCON WITH STAINLESS STEEL INSERT	AIC11004-VS	17.31
	AI TEEJET SPRAY TIPS (TAPERED FLAT SPRAY) VISIFLO COLOR-CODED	ALL SIZES	STAINLESS STEEL/CELCON 110 DEGREE ONLY	AI110015-VS	15.97
	ORIFICE DISCS	ALL SIZES	HARD. STAINLESS STEEL STAINLESS STEEL CERAMIC	D2 DE2 DCER-2	1.79 1.62 4.93
	CORES	ALL SIZES	NYLON BRASS HARD. STAINLESS STEEL CERAMIC	DC23-NY DC23 DC23-HSS DC25-CER	1.62 3.11 7.44 7.49
	ORIFICE PLATES	ALL SIZES	STAINLESS STEEL	CP4916-49	3.76

HYPRO BOOMLESS NOZZLES

	XT BOOMLESS FLAT_FAN NOZZLE	10,20,24,43, 80	STAINLESS STEEL	XT020 XT043 XT080	108.16 126.88 126.88
---	---------------------------------------	--------------------	-----------------	-------------------------	----------------------------

TEEJET BOOMLESS TIP

	XP BOOMJET NOZZLE (BOOMLESS FLAT SPRAY) VISIFLO COLOR-CODED	1/4" 10, 20, 25 1/2" 40 OR 80	ACETAL ACETAL	1/4XP25R-VP 1/2XP40L-VP	60.10 71.58
--	--	----------------------------------	------------------	----------------------------	----------------



BOOMINATOR BOOMLESS SPRAY NOZZLES

BENEFITS - HEAVY DROPLET SIZE FOR MINIMAL DRIFT, SUPERIOR WEAR AND EVEN SPRAY DISTRIBUTION OVER WIDE PATTERN, CAN EASILY SPRAY AROUND OBSTACLES, ELIMINATE COST OF SPRAY BOOMS, WIDE NOZZLE SELECTION FOR DIFFERENT SPRAY VOLUMES AND SPRAY WIDTHS.

APPLICATIONS - FENCE LINES AND RIGHTS OF WAY, DEICING, PASTURES, LAWN, TURF, NURSERY, DITCHBANKS, AQUATIC CONTROL, INSECT CONTROL, DISINFECTING AND DISEASE CONTROL IN LIVESTOCK AND POULTRY BARNs, EXTEND BOOM COVERAGE.

PATTERN SELECTION - SELECT LEFT OF RIGHT NOZZLE WITH REGULAR PATTERN FOR ONE SIDE APPLICATION. USE BOTH FOR WIDE FULL PATTERN. FULL PATTERN NOZZLES SPRAY BOTH SIDES.

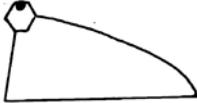
MANY ADDITIONAL SIZES AND PATTERNS AVAILABLE.

REGULAR PATTERN	MODEL	GPM @ 30 PSI	GPA @ 5 MPH	MATERIAL	PATTERN	PRICE
	1160L, R	1.2 GPM	7.5 GPA	STAINLESS	16 FT	105.44
	1250L, R	1.7 GPM	11 GPA	STAINLESS	16 FT	
	1400L, R	2.0 GPM	12 GPA	STAINLESS	17 FT	114.98
	1870L, R	3.5 GPM	19 GPA	STAINLESS	18 FT	124.56
FULL PATTERN	MODEL	GPM @ 30 PSI	GPA @ 5 MPH	MATERIAL	PATTERN	PRICE
	1200PS	1.7 GPM	11 GPA	PLASTIC	16 FT	23.83
	1250FS	1.7 GPM	11 GPA	STAINLESS	16 FT	129.35
	1400FS	2.0 GPM	12 GPA	STAINLESS	17 FT	138.93
	1400FM	2.0 GPM	9 GPA	STAINLESS	22 FT	

SPRAYER ACCESSORIES

NOZZLES BODIES

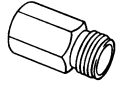

	FPT		
CP1335	1/8" BRASS	\$2.71	
CP1335-AL	1/8" ALUM.	\$2.61	
CP1321	1/4" BRASS	\$2.71	
CP1321-AL	1/4" ALUM.	\$2.61	
CP1321-SS	1/4" STAINLESS	\$17.90	
CP12094-NYB	1/4" NYLON	\$1.88	

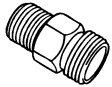

	MPT		
CP1322	1/4" BRASS	\$2.71	
CP1322-AL	1/4" ALUM.	\$2.61	
CP1322-SS	1/4" STAINLESS	\$17.90	
CP8028-NYB	1/4" NYLON	\$1.94	

BALL CHECK NOZZLE BODY



1116-BCN	NYLON	\$3.15	
----------	-------	--------	--

HOSE BARBS

4251-250	1/4" BRASS	\$3.87	
4251-375	3/8" BRASS	\$3.87	
8400-406-NYB	3/8" NYLON	\$1.26	
4251-500	1/2" BRASS	\$3.87	
8400-500-NYB	1/2" NYLON	\$1.26	



NOZZLE CAPS

CP1325	BRASS	\$1.65	
CP1325-AL	ALUM.	\$2.74	
CP1325-SS	STAINLESS	\$9.76	
CP8027-NYB	NYLON	\$1.10	
CP8027-1-NYB	NYLON	\$1.41	



WINGED CAP

CP18032A-NYB	NYLON	\$1.53	
--------------	-------	--------	--



ADAPTERS CAP

4676-1/8	1/8" BRASS	\$3.38	
4676-NYB-1/8	1/8" NYLON	\$2.78	
4676-SS-1/8	1/8" STAINLESS	\$11.42	
4676-1/4	1/4" BRASS	\$3.38	
4676-NYB-1/4	1/4" NYLON	\$2.78	
4676-SS-1/4	1/4" STAINLESS	\$11.42	



CHECK VALVES

11750-5	BRASS	\$7.92
11750-AL-5	ALUM.	\$8.53
11750-PP-5	POLYPROPYLENE	\$6.73
11750-SS-5	STAINLESS	\$25.28



STRAINERS MESH

5053-50-SS	BRASS	50	\$3.42
5053-100-SS	BRASS	100	
8079-NY-50	NYLON-RED	50	\$1.45
8079-NY-100	NYLON-GREEN	100	
8079-PP-50	POLY-RED	50	\$1.45
8079-PP-100	POLY-GREEN	100	
6051-SS-50	STAINLESS	50	\$13.47
6051-SS-100	STAINLESS	100	



BALL CHECK STRAINERS MESH

4193A-5-50SS	BRASS	50	\$6.00
4193A-5-100SS	BRASS	100	
4193A-AL-5-50SS	ALUM.	50	\$5.80
4193A-AL-5-100SS	ALUM.	100	
4193A-PP-5-50SS	POLY-RED	50	\$4.76
4193A-PP-5-100SS	POLY-GREEN	100	
4193A-SS-5-50SS	STAINLESS	50	\$23.58
4193A-SS-5-100SS	STAINLESS	100	

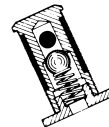

STRAINER REPLACEMENT SCREENS

CP2930-50-SS	50 MESH	\$1.16
CP2930-100-SS	100 MESH	

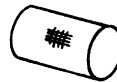

SLOTTED STRAINERS

4514-10	50 MESH BRASS	\$1.62
4514-20	25 MESH BRASS	
4514-32	16 MESH BRASS	
4514-NY-10	50 MESH NYLON-RED	\$1.53
4514-NY-20	MESH NYLON-YELLOW	
4514-NY-32	16 MESH NYLON-GRAY	



ADAPTERS

CP4928	BRASS	\$23.23
CP4928-SS	STAINLESS	\$42.21



NOZZLE BLANKS

CP3942	BRASS	\$0.55
CP3942-AL	ALUM.	
CP3942-SS	STAINLESS	\$0.82



MANIFOLD

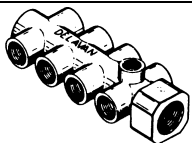

MANIFOLD: THIS MANIFOLD IS NYLON WITH A 3/4" NPTF INLET, EIGHT 1/2" NPTF OUTLETS AND A 1/4" NPTF GAUGE OUTLET. MAY BE USED ON SPRAY KITS AND SOME BOOM SPRAYING SYSTEMS.
INLET(NPTF): 3/4" **OUTLET(NPTF):** 1/2"
PRESSURE: 0-100 PSIG; **MAX. RECOMMENDED TEMPERATURE:** 120 DEGREES F 50 DEGREES C

36516-3 8-WAY MANIFOLD **\$18.80**

SPRAYER ACCESSORIES

BOOM TEE

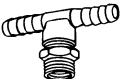
	6472B-400TD	3/8" BRASS	\$15.13
	8120-NYB-406TD	3/8" NYLON	\$3.76
	900.053	1/2" BRASS	\$6.80
	9192B-531TD	1/2" BRASS	\$15.13
	8120-NYB-540TD	1/2" NYLON	\$3.76
	5858-TT	5/8" NYLON	\$1.81
	3434-TT	3/4" NYLON	\$1.81
	12202-CE-785TD	3/4" CELCON	\$16.24
	12202-CE-1062TD	1" CELCON	\$16.24

BOOM EL

	6471B-400TD	3/8" BRASS	\$14.39
	8121-NYB-406TD	3/8" NYLON	\$3.57
	900.052	1/2" BRASS	\$7.20
	9191B-531TD	1/2" BRASS	\$14.39
	8121-NYB-540TD	1/2" NYLON	\$3.57
	58-TL	5/8" NYLON	\$1.81
	34-TL	3/4" NYLON	\$1.81
	12201-CE-785TD	3/4" CELCON	\$16.24
	12201-CE-1062TD	1" CELCON	\$16.24

BOOM STRAIGHT FITTING

	3812D	11/16 X 1/2"	\$0.94
	38D	11/16 X 3/8"	\$0.94

NOZZLE FITTING: CROSS-BARBS BY MALE W/UT

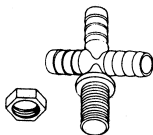
	T38C	11/16MPS X 3/8"	\$1.08
	T12C	11/16MPS X 1/2"	\$1.27
	T34C	11/16MPS X 3/4"	\$1.34

SQUARE BOOM CLAMPS

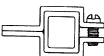
	AA111SQ-1	1" CLAMP	\$6.27
	AA111SQ-1-1/4	1 1/4" CLAMP	\$9.43
	AA111SQ-1-1/2	1 1/2" CLAMP	\$11.21

ROUND BOOM CLAMPS

	AA111-1/2	1/2" CLAMP	\$5.46
	AA111-3/4	3/4" CLAMP	
	AA111-1	1" CLAMP	
	AA111-1-1/4	1 1/4" CLAMP	\$9.13

EYELET NOZZLE LESS PARTS

	7421-1/2T	1/2" BRASS	\$8.55
	7421-3/4T	3/4" BRASS	
	7421-1T	1" BRASS	
	7421-1/2T-NYB	1/2" NYLON	\$4.68
	7421-3/4T-NYB	3/4" NYLON	
	7421-1T-NYB	1" NYLON	

SINGLE SWIVEL SPRAY NOZZLE

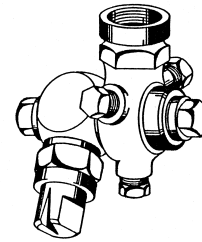

LARGE CAPACITY SINGLE SWIVEL SPRAY NOZZLE WITH OFF-CENTER FLAT SPRAY TIP. 3/4" NPT FEMALE INLET CONNECTION. BRASS COMPONENTS. **4629-3/4-TOC10** OTHER SIZES AVAILABLE

\$205.09

BOOMLESS NOZZLE WITH EXTRA-WIDE FLAT SPRAY TWO OFF CENTER TIPS AND 3 VEEJET NOZZLES **5880-3/4-2TOC10** OTHER SIZES AVAILABLE

\$310.65

SWIVEL NOZZLE BODIES

SINGLE SWIVEL-FEMALE

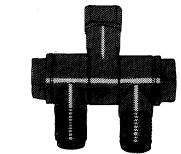

DOUBLE SWIVEL- FEMALE

900.049	1/4" SINGLE BRASS - MALE	\$17.57
5540-1/4TT	1/4" SINGLE BRASS - MALE	\$23.52
5000-1/8T	1/8" SINGLE BRASS - FEMALE	\$21.28
900.003	1/4" SINGLE BRASS - FEMALE	\$12.48
5000-1/4T	1/4" SINGLE BRASS - FEMALE	\$21.28
8600-1/4T-NYB	1/4" SINGLE NYLON - FEMALE	\$10.20
4202-2-1/4T	1/4" DOUBLE BRASS-FEMALE	\$28.84
8600-2-1/4T-NYB	1/4" DOUBLE NYLON-FEMALE	\$12.32

DIAPHRAGM CHECK VALVES

TYPE 8360

1/4" NPT MALE INLET, FLOW RATES UP TO 2 GPM., LENGTH 2". WEIGHT 1 OZ.

8360-NYB

\$19.77

TYPE 8355

OPENS AT 7 PSI, CHOICE OF 1/8" OR 1/4" NPT FEMALE INLET FLOW RATES UP TO 2 1/2 GPM, LENGTH 2 7/8". WEIGHT 1 1/2 OZ.

8355-1/8-NYB

\$12.44

8355-1/4-NYB

\$12.44

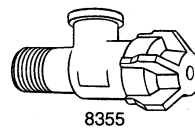

8355

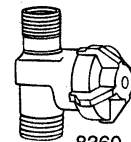

8360

QUICK TEEJET NOZZLE BODIES

FOR DRY BOOMS

QJ100 SERIES HOSE SHANK NOZZLE BODIES (LESS CLAMPS)



PART NO. SINGLE	TO FIT HOSE I.D.	PRICE
18635-111-406-NYB	3/8"	4.83
18638-111-540-NYB	1/2"	
18719-111-785-NYB	3/4"	

PART NO. DOUBLE	TO FIT HOSE I.D.	PRICE
18636-112-406-NYB	3/8"	4.83
18639-112-540-NYB	1/2"	
18720-112-785-NYB	3/4"	

PART NO. TRIPLE	TO FIT HOSE I.D.	PRICE
18637-113-406-NYB	3/8"	4.83
18640-113-540-NYB	1/2"	
18721-113-785-NYB	3/4"	

QJ300 SERIES HOSE SHANK DIAPHRAGM CHECK VALVES

HI-PRESSURE QUICK TEEJET (UP TO 300 psi) (LESS CLAMPS) (OPENS AT 10 PSI)

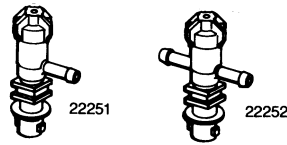

PART NO. SINGLE	TO FIT HOSE I.D.	PRICE
22251-311-375-NYB	3/8"	9.87
22251-311-500-NYB	1/2"	
22251-311-750-NYB	3/4"	
DOUBLE		
22252-312-375-NYB	3/8"	9.87
22252-312-500-NYB	1/2"	
22252-312-750-NYB	3/4"	

QJ360 NOZZLE BODY SERIES (OPENS AT 10 PSI)

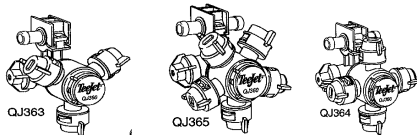

PART NO. SINGLE	PART NO. DOUBLE	# OF SPRAY OUTLETS	TO FIT HOSE I.D.	PRICE
QJ363C-500-1-NYB	QJ363C-500-2-NYB	3	1/2"	23.31
QJ363C-750-1-NYB	QJ363C-750-2-NYB	3	3/4"	
QJ363C-1000-1-NYB	QJ363C-1000-2-NYB	3	1"	
QJ364C-500-1-NYB	QJ364C-500-2-NYB	4	1/2"	23.31
QJ364C-750-1-NYB	QJ364C-750-2-NYB	4	3/4"	
QJ364C-1000-1-NYB	QJ364C-1000-2-NYB	4	1"	
QJ365C-500-1-NYB	QJ365C-500-2-NYB	5	1/2"	23.31
QJ365C-750-1-NYB	QJ365C-750-2-NYB	5	3/4"	
QJ365C-1000-1-NYB	QJ365C-1000-2-NYB	5	1"	
NO BARB				
QJ363C- -NYB	SPECIFY PIPE SIZE	3	1/2, 3/4, 1	18.66
QJ364C- -NYB	SPECIFY PIPE SIZE	4	1/2, 3/4, 1	
QJ365C- -NYB	SPECIFY PIPE SIZE	5	1/2, 3/4, 1	

REPLACEMENTS BARBS - SEE BLUE SECTION PAGE FOR PARTS

PART#	DESCRIPTION	PRICE
CP38936-NYB	1/2" SINGLE HOSE BARB	2.85
CP38938-NYB	3/4" SINGLE HOSE BARB	
CP38940-NYB	1" SINGLE HOSE BARB	
CP38937-NYB	1/2" DOUBLE HOSE BARB	3.38
CP38939-NYB	3/4" DOUBLE HOSE BARB	
CP38941-NYB	1" DOUBLE HOSE BARB	

VARI-SPACING CLAMPS



PART NO.	TO CLAMP ON	PRICE
QJ111-1/2	1/2" PIPE (13/16" & 7/8" O.D. TUBINGS)	3.19
QJ111-3/4	3/4" PIPE (1" & 1 1/16" O.D. TUBINGS)	
QJ111-1	1" PIPE (1 1/8", 1 1/4" & 1 3/8" O.D. TUBINGS)	
QJ111-1-1/4	1 1/4" PIPE (1 9/16" & 1 11/16" O.D. TUBINGS)	
QJ111SQ-3/4	3/4" SQUARE TUBING	
QJ111SQ-1	1" SQUARE TUBING	
QJ111SQ-1 1/4	1 1/4" SQUARE TUBING	
QJ111SQ-1 1/2	1 1/2" SQUARE TUBING	

FOR WET BOOMS

SPLIT EYELETS (OPENS AT 10 PSI)

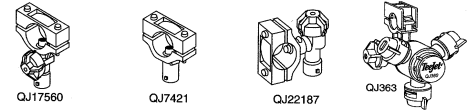

PART NO.	TO CLAMP ON	PRICE
QJ17560A-1/2-NYB	1/2" PIPE	5.23
QJ17560A-3/4-NYB	3/4" PIPE	
QJ17560A-1-NYB	1" PIPE	
QJ7421-1/2-NYB	1/2" PIPE	4.85
QJ7421-3/4-NYB	3/4" PIPE	
QJ7421-1-NYB	1" PIPE	12.20
QJ22187-1/2-NYB	1/2" PIPE	
QJ22187-3/4-NYB	3/4" PIPE	
QJ22187-1-NYB	1" PIPE	18.66
QJ363C-1/2-NYB	1/2" PIPE	
QJ363C-3/4-NYB	3/4" PIPE	
QJ363C-1-NYB	1" PIPE	

(USED ON NEWER JOHN DEERE 4700)

DIAPHRAGM CHECK VALVES

DIAPHRAGM CHECK VALVE QUICK TEEJET NOZZLE BODY ASSEMBLY

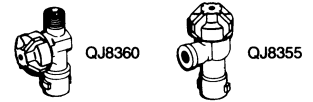

PART NO.	PIPE CONNECTION	PRICE
QJ8360-NYB	1/4" NPT (M) 10 PSI	6.02
QJ38621-NYB(YELLOW)	1/4" NPT (M) 2 PSI	12.09
QJ8355-1/8-NYB	1/8" NPT (F) 10 PSI	
QJ8355-1/4-NYB	1/4" NPT (F) 10 PSI	

NOZZLE BODY QUICK TEEJET NOZZLE BODY

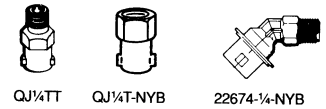

PART NO.	PIPE CONNECTION	PRICE
QJ1/4TT-NYB	1/4" NPT (M)	3.31
QJ1/4T-NYB	1/4" NPT (F)	
22674-1/4-NYB	1/4" NPT (F)	

SWIVELS AND ADAPTERS

SWIVELS QJ8600 SWIVEL QUICK TEEJET NOZZLE BODY ASSEMBLIES

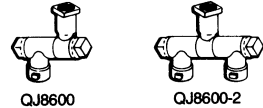

PART NO.	PIPE CONNECTION	PRICE
SINGLE SWIVEL QJ8600-1/4-NYB	1/4" NPT (F)	8.80
DOUBLE SWIVEL QJ8600-2-1/4-NYB	1/4" NPT (F)	10.59

ADAPTERS FOR RETROFITTING (OPENS AT 10 PSI)

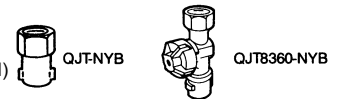

PART NO.	TO FIT	PRICE
QJT-NYB	11/16" - 16 TEEJET	6.13
QJT8360-NYB	THREAD 11/16" - 16 TEEJET	6.55
	THREAD	

VALVES

TeeJet TEEVALVE

ALUMINUM CONSTRUCTION WITH STAINLESS STEEL AND PLASTIC INTERNAL PARTS FOR MAXIMUM CORROSION RESISTANCE. FOR HANDLING MOST FARM CHEMICALS AND NITROGEN LIQUID FERTILIZERS.

FOR SELECTIVE CONTROL OF THREE SECTION BOOM SPRAYERS AT PRESSURES UP TO 300 PSI. SEE BLUE SECTION FOR REPAIR PARTS

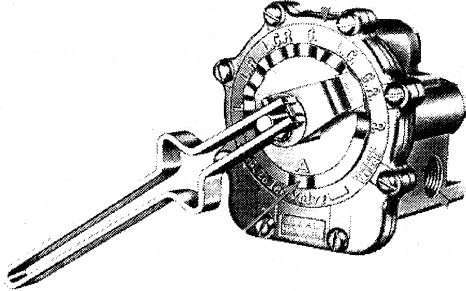

AA17L TEEVALVE \$155.92

TeeJet DIRECTOVALVE

MOLDED OF CORROSION RESISTANT MATERIALS, ALL WETTED PARTS ARE POLYPROPYLENE AND STAINLESS STEEL

VALVES CAN BE GANGED TOGETHER USING HEX NIPPLE FOR MULTIPLE-BOOM CONTROL
 MAXIMUM PRESSURE OF 150 PSI
 LARGE CAPACITY, 12.5 GPM AT 5 PSI PRESSURE DROP
 SEE BLUE SECTION FOR REPAIR PARTS

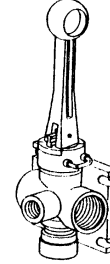

AA6B DIRECTOVALVE \$61.39

PRESSURE RELIEF VALVES TO BE USED WITH ROLLER AND DIAPHRAGM PUMPS

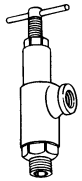

6815 PRESSURE RELIEF VALVE
 6815-1/2-300 BRASS 0-300 PSI
 6815-3/4-300 BRASS 0-300 PSI \$88.58
 6815-1/2-50-VI BRASS 0-50 PSI VITON \$97.43

TeeJet



110 PRESSURE RELIEF VALVE
 AA110-1/4-50 BRASS 0-50 PSI
 AA110-1/4-300 BRASS 0-300 PSI
 AA110-3/8-50 BRASS 0-50 PSI \$66.68
 AA110-3/8-300 BRASS 0-300 PSI

TeeJet

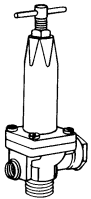

8460 PRESSURE RELIEF VALVE
 300 PSI
 8460-1/2 1/2" \$76.33
 8460-3/4 3/4"

TeeJet

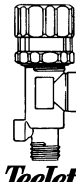

23120 PRESSURE RELIEF VALVE
 150 PSI
 23120-1/2-PP POLYPROPYLENE \$41.59
 23120-3/4-PP POLYPROPYLENE
 23120A-1/2-PP POLYPROPYLENE \$62.81
 W/VITON & 316SS
 23120A-3/4-PP POLYPROPYLENE
 W/VITON & 316SS

TeeJet

TeeJet THROTTLING VALVES

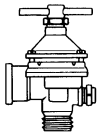

125 PSI
 12690-1/2-NYB 1/2" NPT CONNECTIONS \$112.15
 12690-3/4-NYB 3/4" NPT CONNECTIONS

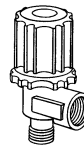

150 PSI
 23520-1/2-PP 1/2" NPT CONNECTIONS \$36.04
 23520-3/4-PP 3/4" NPT CONNECTIONS

SPRAYER CONTROL SYSTEMS

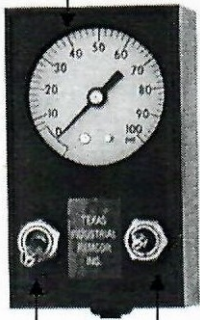

CON.RC10N **\$364.14**

CONTROLS SINGLE SOLENOID OR SINGLE MOTORIZED BALL VALVE. ALSO ALLOWS PRESSURE ADJUSTMENT



TEEJET **90-50161** **\$375.29**

CONTROLS UP TO 3 SOLENOIDS OR MOTORIZED BALL VALVE. HAS MASTER SWITCH AS WELL AS PRESSURE ADJUST SWITCH AND LIQUID GAUGE

RAVEN AUTOMATIC RATE CONTROLLER

063-0171-220 450 CONSOLE, 6 BOOM SECTION \$2498.40

PLEASE CALL THE OFFICE FOR CORRECT CABLES



SPEED SENSOR OPTIONS

90-02404 GPS SPEED SENSOR
117-0171-249 CRUIZER II W/HELIX ANTENNA



\$531.40
\$2739.80

OPTIONAL AND REPLACEMENT COMPONENTS



063-0159-001 3/4" STANDARD CONTROL VALVE FOR SCS-11 AND SCS-203 \$144.00



117-0159-007 REPLACEMENT GAUGE KIT ASSEMBLY FOR SCS-11 \$57.60

417-0001-004 GAUGE ONLY FOR SCS-11 1/4" BOTTOM PORT \$37.44

117-0159-006 REPLACEMENT GAUGE KIT ASSEMBLY FOR SCS-203 \$69.12

417-0001-002 GAUGE ONLY FOR SCS-203 1/8" BACKPORT \$37.44



063-0172-125 1" POLY CONTROL VALVE FOR USE WITH 440 CONTROL \$436.32



063-0171-985 STANDARD FLOW METER FOR 440, 1-60 GPM \$673.92

063-0172-040 OPTIONAL FLOW METER .3-15 GPM FOR USE WITH TURF PLANTER \$496.80

063-0173-578 FLOW METER 5-100 GPM FOR LARGE RATES SUCH AS FERTILIZER APPLICATION \$1000.80

TEEJET

CONTROLS AND ACCESSORIES



PART NO.	QTY.	DESCRIPTION	PRICE
90-50161	1	744A-100L-3 SPRAYER CONTROL UNIT/LIQUID GAUGE 244A-3/4 PRESSURE REGULATING VALVE	375.29
90-50163	1	744A-100L-3 SPRAYER CONTROL UNIT/LIQUID GAUGE 244A-3/4 PRESSURE REGULATING VALVE	601.61
	3	144A DIRECTO VALVE NOOM SECTION VALVES	
90-50171	1	744A-300L-3 SPRAYER CONTROL UNIT/LIQUID GAUGE 344-2PR PRESSURE REGULATING VALVE	612.47
90-50255	1	744E MANUAL CONTROL, 75-50061 100 PSI PRESSURE GAUGE, 5 SECTION AND POWER CABLE	767.11

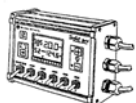

844-E

TEEJET AUTOMATIC RATE CONTROLLERS

90-50017	844-E 5 SWITCH CORE INCLUDING CONSOLE AND CABLE	1666.64
90-50223	844-E AUTOMATIC SPRAYER CONTROL KIT INCLUDING CONSOLE, CABLES, REGULATING VALVE, AND FLOW METER	2237.93



GPS SPEED
SENSOR

SPEED SENSOR OPTIONS

90-02386	GPS SPEED SENSOR - 844-E TEEJET	531.40
90-02404	GPS SPEED SENSOR - RAVEN 440	531.40



REGULATING
VALVE

OPTIONAL AND REPLACEMENT COMPONENTS

35-50029	STANDARD CONTROL VALVE FOR 744 CONTROL	128.74
35-02099	STANDARD CONTROL VALVE FOR 844-E RATE CONTROLLER	257.88
90-50230	STANDARD RAPID CHECK FLOW METER 2.5-60 GPM	510.87
90-02308	OPTIONAL LOW FLOW METER FOR TURF AND PLANTER APPLICATIONS	374.10
57-10079	OPTIONAL HIGH FLOW METER FOR FERTILIZER APPLICATIONS	809.79

BOOM VALVE ASSEMBLIES FOR AUTOMATIC RATE CONTROLLERS

SHOWN ON PAGE 35 & 36

AC144A-3-CPT	TRIPLE SOLENOID ASSEMBLY INCLUDES 3 SOLENOIDS, MOUNTING BRACKET AND ALL NECESSARY FITTINGS	559.42
AC443-CPT	THREE VALVE MANIFOLD ASSEMBLY INCLUDES 3 - 344BEC ELECTRIC BALL VALVES, MOUNTING BRACKET AND ALL NECESSARY FITTINGS.	1234.43
AC445-CPT	FIVE VALVE MANIFOLD ASSEMBLY INCLUDES 5 - 344BEC ELECTRIC BALL VALVES. WORKS WELL WITH AUTOMATIC BOOM SECTION CONTROL (CENTERLINE 230 BOOM PILOT)TO PREVENT UNNECESSARY OVERLAP.	1778.16



FLOW METER

840G MATRIX



TEEJET GUIDANCE

90-02399	CENTERLINE 220	1158.73
GD430-GLO-P-B	KIT 430, MATRIX PATCH ANTENNA, BATTERY LEADS	1669.14
90-02815	KIT, 570G MATRIX, RXA-30, ANTENNA, NO CAM., CIGARETTE LIGHTER ADAPTER	3245.95
90-02832	KIT, 840G MATRIX, RXA-30, ANTENNA, NO CAM, CIGARETTE LIGHTER ADAPTER	4255.05
90-02666	KIT, BOOMPILOT SDM/HARNESS (MUST HAVE AUTO-RATE CONTROLLER)	1616.54

OPTIONAL AND COMPONENT PARTS

45-20042	GPS ADAPTER CABLE TO SEND SPEED TO 844-E CONTROLLER FROM CENTERLINE 220	86.49
45-05508	GPS ADAPTER CABLE TO SEND SPEED TO 440 RAVEN	86.49
78-50190	GPS PATCH ANTENNA (WILL WORK FOR CENTERLINE 220 AND 230)	224.08
90-02092	MOUNT FOR ANTENNA ABOVE TO USE ON PLASTIC SURFACES	29.34
51-20007	PRESSURE GAUGE, 300 PSI LIQUID	59.36
51-20008	PRESSURE GAUGE, 100 PSI LIQUID	53.37

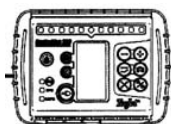

CENTERLINE
220

CONTROL ASSEMBLIES COMPLETE



SINGLE SOLENOID ASSEMBLY. SET UP FOR CENTRIFUGAL PUMP. INCLUDES MOTORIZED BUTTERFLY CONTROL VALVE, 144A-1 SOLENOID, INLET STRAINER, AND MOUNTING BRACKET. PORTS: INLET 1", DISCHARGE 1/2", AGITATION 1/2", BY-PASS 3/4" ALTERNATE FITTINGS BY REQUEST.

RC10N-CPT441/C SINGLE BALL VALVE ASSEMBLY \$893.08

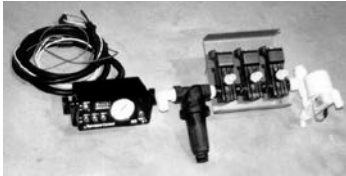

TRIPLE SOLENOID ASSEMBLY. SET UP FOR CENTRIFUGAL PUMPS. INCLUDES TEEJET 744 CONSOLE CONSOLE, MOTORIZED BUTTERFLY CONTROL VALVE, 144A-3 SOLENOID, INLET STRAINER AND MOUNTING BRACKET. PORTS: INLET 1", DISCHARGE 3/4", AGITATION 1/2", BY-PASS 3/4". ALTERNATE FITTINGS BY REQUEST.

744A100L33SCPTC SOLENOID CONTROL \$702.57



TRIPLE BALL VALVE ASSEMBLY. INCLUDES BUTTERFLY VALVE PROVIDES REMOTE PRESSURE CONTROL, THREE 344BEC MOTORIZED BALL VALVES, INLET STRAINER, AND MOUNTING BRACKET. PORTS: INLET 1", DISCHARGE 3/4", AGITATORS 1/2", BYPASS 3/4". ALTERNATE FITTINGS BY REQUEST.

744AL-CPT443 BALL VALVE CONTROL CPT \$1514.60

SPRAY MONITORS (REPLACEMENT PARTS BLUE SECTION PAGE 13)

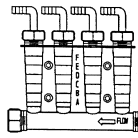
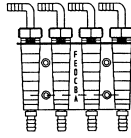
<u>REDBALL MONITORS</u>		<u>PRICE</u>			<u>PRICE</u>		
	PART NO. 3376-0002	MANIFOLD ASSY - 3/8" USE W/PRESSURE PUMP	79.00		PART NO. 3376-0004	FOR SQUEEZE PUMPS 4-COLUMN ASSY - 3/8"	84.00
	3376-0008	1/2" USE W/PRESSURE PUMP	79.00		3376-0005	4 COLUMN ASSY - 1/2" 2	84.00
					3376-0006	COLUMN ASSY - 3/8" 2	55.00
					3376-0007	COLUMN ASSY - 1/2"	55.00

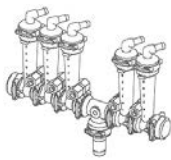
<u>PART NO.</u>	<u>WILGER MODULAR FLOW INDICATORS - VITON O'RINGS</u>	<u>PRICE</u>
	WIL-4-VO 4 COLUMN ASSY W/3/4"INLETS, 3/8"OUTLETS, AND END CAPS	116.45
	WIL-5-VO 5 COLUMN ASSY W/3/4"INLETS, 3/8"OUTLETS, AND END CAPS	141.25
	WIL-8-VO 8 COLUMN ASSY W/1"FEMALE TEE INLETS, 3/8"OUTLETS, AND END CAPS	229.85
	WIL-9-VO 9 COLUMN ASSY W/1"FEMALE TEE INLETS, 3/8"OUTLETS, AND END CAPS	256.37
	WIL-12-VO 12 COLUMN ASSY W/1"FEMALE TEE INLETS, 3/8"OUTLETS, AND END CAPS	346.00
	WIL-13-VO 13 COLUMN ASSY W/1"FEMALE TEE INLETS, 3/8"OUTLETS, AND END CAPS	375.75

JOHN BLUE FLOW MONITORS

<u>PART NO.</u>		<u>PRICE</u>
	SMSS1 CDS-JOHN BLUE VISAGAGE II CAN BE USED FOR SPRAYING OR FERTILIZER APPLICATION. THE EXACT NUMBER OF FLOW MONITORS CAN BE MADE BY BANDING TOGETHER SINGLE COLUMNS. VITON O'RINGS ARE STANDARD. MOST CDS-JOHN BLUE FLOW MONITOR PARTS ARE INTERCHANGEABLE WITH OTHER BRANDS ALREADY ON THE MARKET.	25.90
	SMSS4	82.91

MOUNTING BRACKETS FOR SPRAY MONITORS

<u>PART NO.</u>		<u>PRICE</u>
JBPL-WIL-8	BKT FOR 4,6, & 8 ROW MONITOR	57.58
JBPL-WIL-12	BKT FOR 12 AND 13 ROW MONITOR	58.40
JBPL-WIL-16	BKT FOR 16 ROW MONITOR	88.55

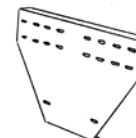

PRESSURE GAUGES

STANDARD PRESSURE GAUGES

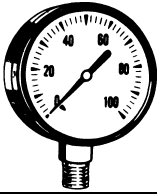

<u>PART NO.</u>	<u>DIAL SIZE</u>	<u>PRESSURE RANGE</u>	<u>MOUNTING</u>	<u>PRICE</u>
PG-ST-060	2 1/2"	0-60	1/4" NPT BOTTOM	10.65
PG-ST-100	2 1/2"	0-100	1/4" NPT BOTTOM	10.65
PG-ST-200	2 1/2"	0-200	1/4" NPT BOTTOM	10.65
PG-ST-300	2 1/2"	0-300	1/4" NPT BOTTOM	10.65
PG-ST-1004	4 1/2"	0-100	1/4" NPT BOTTOM	22.05

GLYCERIN-FILLED PRESSURE GAUGES

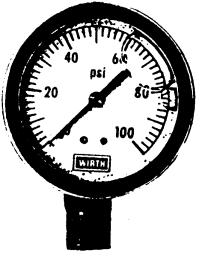

PG-GF-30	2 1/2"	0-30	1/4" NPT BOTTOM	23.70
PG-GF-60	2 1/2"	0-60	1/4" NPT BOTTOM	23.70
PG-GF-100	2 1/2"	0-100	1/4" NPT BOTTOM	23.70
PG-GF-160	2 1/2"	0-160	1/4" NPT BOTTOM	23.70
PG-GF-200	2 1/2"	0-200	1/4" NPT BOTTOM	23.70
PG-GF-300	2 1/2"	0-300	1/4" NPT BOTTOM	23.70
PG-GF-600	2 1/2"	0-600	1/4" NPT BOTTOM	23.70
PG-GF-1000	2 1/2"	0-1000	1/4" NPT BOTTOM	23.70
PG-GF-2000	2 1/2"	0-2000	1/4" NPT BOTTOM	23.70
PG-GF-3000	2 1/2"	0-3000	1/4" NPT BOTTOM	23.70
PG-GF-4000	2 1/2"	0-4000	1/4" NPT BOTTOM	23.70
PG-GF-5000	2 1/2"	0-5000	1/4" NPT BOTTOM	23.70
PG-GF-10000	2 1/2"	0-10000	1/4" NPT BOTTOM	23.70
PG-GF-1004	4"	0-100	1/4" NPT BOTTOM	92.50

STAINLESS STEEL GLYCERIN-FILLED PRESSURE GAUGES



<u>PART NO.</u>	<u>DIAL SIZE</u>	<u>PRESSURE RANGE</u>	<u>MOUNTING</u>	<u>PRICE</u>
PG-GF-SS-60	2 1/2"	0-60	1/4" NPT BOTTOM	52.40
PG-GF-SS-100	2 1/2"	0-100	1/4" NPT BOTTOM	52.40
PG-GF-SS-160	2 1/2"	0-160	1/4" NPT BOTTOM	52.40

PRESSURE GAUGE – BACK PORT STANDARD AND GLYCERIN FILLED

<u>PART NO.</u>	<u>DIAL SIZE</u>	<u>PRESSURE RANGE</u>	<u>MOUNTING</u>	<u>PRICE</u>
PG-ST-100-2	2 1/2"	0-100	1/4" NPT BACK	9.05
PG-GF-100B	2 1/2"	0-100	1/4" NPT BACK	23.70
PG-GF-160B	2 1/2"	0-160	1/4" NPT BACK	23.70
PG-GF-200B	2 1/2"	0-200	1/4" NPT BACK	23.70
PG-GF-300B	2 1/2"	0-300	1/4" NPT BACK	23.70
PG-GF-1000B	2 1/2"	0-1000	1/4" NPT BACK	23.70

GAUGE WITH PROTECTOR



<u>PART NO.</u>	<u>PRESSURE RANGE</u>
*PG-PF-160	0-160

*FLUOROCARBON \$67.75

<u>DIAL SIZE</u>	<u>MOUNTING</u>
2 1/2"	1/4" NPT BOTTOM

GAUGE ISOLATOR



PART NO. 22470A-1/4 \$102.73
 DESIGNED TO PROTECT PRESSURE GAUGES FROM CORROSIVE CHEMICALS. 1/4" NPT (F) CONNECTIONS. GAUGE SIDE OF DAMPENER REQUIRES GLYCERIN OR ATF FILL.

PART NO. 2300 CHEMICAL ISOLATOR KIT \$87.75
 KIT WITH MOUNTING BRACKET AND FITTINGS FOR BOTH 1/8" AND 1/4" TUBING. LARGE CAPACITY ASSURES ACCURATE PRESSURE READING. 150 PSI MAX. PRE-FILLED AT THE FACTORY WITH NON TOXIC RV ANTIFREEZE.

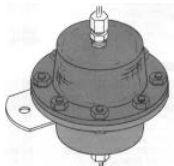

NYLON GAUGE TEE
 NYLON PIPE FITTING
 GAUGE PORT FEMALE TEE THREAD 3/4"
 GAUGE PORT 1/4 FPT, PORT ON SIDE
 B34-14 \$7.85



POLY GAUGE TEE
 POLY PIPE FITTING
 1/4" FEMALE THREAD(GAUGE NOT INCLUDED)
 PORT ON TOP
 TEG075 3/4" POLY TEE \$24.43
 TEG100 1" POLY TEE \$24.43

DIRECTO VALVE CONTROL VALVES

*OPERATING PRESSURE RANGE 0 TO 100 PSI
 *5 PSI PRESSURE DROP WITH 10 GPM FLOW CAPACITIES
 *POLYPROPYLENE VALVE BODY

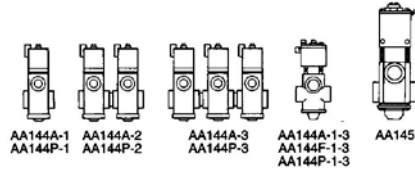

SOLENOID DIRECTO VALVE

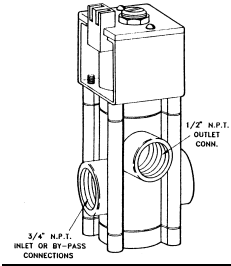

MODEL	INLET-BY-PASS 3/4"	OUTLET	GPM FLOW	PSI RATING	PRICE
AA144A-1		1/2"	10	100	186.66
AA144A-2	3/4"	1/2"	10	100	378.13
AA144A-3	3/4"	1/2"	10	100	569.63
AA144P-1	3/4"	1/2"	10	100	257.25
AA144A-1-VI	3/4"	1/2"	10	100	219.93
AA144A-3-VI	3/4"	1/2"	10	100	660.82
AA144A-1-3	3/4"	DUAL 1/2"	8	65	253.99
AA145 H-1	1"	1"	18	100	427.37

MOTORIZED BALL VALVES

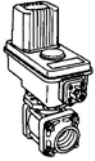

BE VALVES REQUIRED BEC
 VALVES REQUIRED

MODEL	DESCRIPTION	PRICE
344BE-23-C	DPDT SWITCHES 3/4" ELECTRICALLY OPERATED, 2 WAY, NYLON	369.58
344BE-24-C	SPST SWITCHES 1"	
344BE-33-C	3/4" ELECTRICALLY OPERATED, 3 WAY, NYLON	452.29
344BE-34-C	1"	
344BEC-23-C	3/4" ELECTRICALLY OPERATED, 2 WAY, NYLON	369.58
344BEC-24-C	1"	
344BEC-23-CJ	3/4" VALVE WITH SPRAYER CONTROL CONNECTION	378.35
344BEC-24-CJ	1"	
344BEC-33-C	3/4" ELECTRICALLY OPERATED, 3 WAY, NYLON	452.29
344BEC-34-C	1"	

DIRECTO VALVE MANIFOLD

440B MANIFOLD

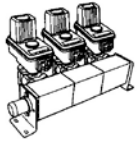

441BEC-34T4T-C	1 VALVE MANIFOLD ASSEMBLY	461.25
442BEC-34T4T-C	2 VALVE MANIFOLD	891.91
56606-2-443BEC	3 VALVE MANIFOLD (SAME AS AA443AEC-3-4T-4T WITH ELECTRICAL ENDS)	1386.58

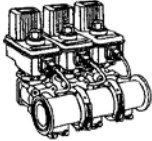

450B MANIFOLD

453BEC-2NF-C	3 VALVE MANIFOLD WITH FLANGED INLET AND OUTLET. OUTLET MAYBE FLANGED OR THREADED. CONSULT REDDICK. MODEL SHOWN IS NARROW CONFIGURATION TO USE LESS SPACE. AVAILABLE IN 1 VALVE TO 5 VALVE MANIFOLD. USE SAME MOTORS AS 440B SERIES VALVES.	1184.06
45-20096	BATTERY END CABLE ASSY. (12 FT)	42.39
45-20097	VALVE END CABLE ASSY. (8 FT)	31.51

PRESSURE REGULATING VALVE



AA244C

35-50029	3/4" NPT CONNECTIONS, NYLON BODY WITH POLYPROPYLENE COVER	128.74
----------	---	--------

BANJO BALL VALVES

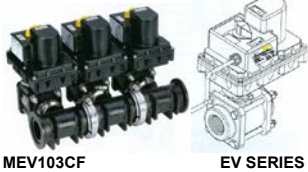

MEV103CF

EV SERIES

EV075	3/4" ELECTRICAL BALL VALVE	541.11
EV100FP	1" ELECTRICAL BALL VALVE	
EV125	1 1/4" ELECTRICAL BALL VALVE	
EV150	1 1/2" ELECTRICAL BALL VALVE	793.19
EV200	2" ELECTRICAL BALL VALVE	
EV204FP	2" FULL PORT ELECTRICAL BALL VALVE	837.25
EV4300	MOTOR ASSY ONLY	478.54
MEV103CF	1" MANIFOLD VALVE ASSY. (2" INLET FLANGE, 1" OUTLET FLANGE)	1665.71

STRAINERS

TeeJet LINE STRAINERS

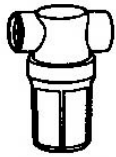

PART NO.
AA122-1/2-PP-50
AA122-3/4-PP-50

DESCRIPTION
150 PSI
1/2" POLY STRAINER WITH 50 MESH - RED
3/4" POLY STRAINER WITH 50 MESH - RED

PRICE
21.38

AA126 FLUSH OUT LINE STRAINER W/MOUNTING LUG

200 PSI
STRAINER HEAD AND BOWL ARE MADE OF GLASS-FILLED
POLYPROPYLENE WITH EPDM GASKET
SCREENS ARE MADE OF 304SS WITH COLOR-CODED
POLYPROPYLENE FRAMES AND ARE REMOVABLE FOR CLEANING
REMOVABLE CAP AND GASKET FOR FLUSH OUT OR SELF CLEANING
OPERATIONS
INTEGRAL MOUNTING PROVISION ALLOWS THE STRAINER TO BE
ATTACHED TO MACHINE

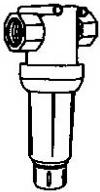

AA126ML-3-50 3/4" STRAINER 50 MESH - RED
AA126ML-4-50 1" STRAINER 50 MESH - RED
AA126ML-4-100 1" STRAINER 100 MESH - GREEN
AA126ML-F50-50 FLANGED STRAINER 50 SERIES - RED
AA126ML-5-50 1 1/4" STRAINER 50 MESH - RED
AA126ML-6-50 1 1/2" STRAINER 50 MESH - RED
AA126ML-6-16 1 1/2" STRAINER 16 MESH - GRAY
AA126ML-6-80
AA126ML-F75-50 1 1/2" STRAINER FLANGED - 50 MESH RED, 80 MESH
AA126ML-F75-100 BLUE, 100 MESH BLUE

39.47
80.78

HYPRO LINE STRAINERS

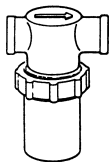

PART NO.	DESCRIPTION	PRICE
3350-0079A	1/4" ID & 1/2" OD 50	12.23
3350-0044	MESH 3/4" - 50 MESH	25.92
3350-0061	1" - 50 MESH	41.08
3350-0075	1 1/4" - 50 MESH	47.32
3350-0116	1 1/2" - 50 MESH	51.74

3350-0034A 3/4" - 50 MESH 20.09

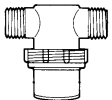

3350-0079F 1/4" ID(F) & 1/2" OD(M) 50 MESH 17.47

12V LAWN & GARDEN STRAINER

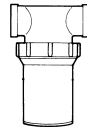

RVLF66PE40C \$13.50
3/8" FEMALE STRAINER W/CLEAR BOWL

TeeJet ATW LINE STRAINER



PART NO.	DESCRIPTION	PRICE
1/2 ATW-B50	BRASS	116.84

TeeJet 3/4Q LINE STRAINER



PART NO.	DESCRIPTION	PRICE
3/4Q-50	3/4" FPT x 3/4" FPT BRASS-50 MESH	77.19



POLYPROPYLENE "T" STRAINERS

- HEAVY DUTY GLASS REINFORCED POLYPROPYLENE
- CLEAN-OUT PLUG
- 304 STAINLESS STEEL REINFORCED SCREENS
- EPDM GASKETS. VITON AVAILABLE
- 150 PSI AT 70 DEGREES
- RECOMMENDATION: USE 50, 80, OR 100 MESH SCREENS FOR ROLLER AND CENTRIFUGAL PUMPS. USE 16, 20, OR 30 MESH FOR DIAPHRAGM PUMPS.



<u>PART NO</u>	<u>DESCRIPTION</u>	<u>PRICE</u>
LST075-50	3/4" - 50 MESH - BLUE	43.22
LST100-16	1" - 16 MESH - BROWN RED	47.53
LST100-30	1" - 30 MESH - FLAME RED	
LST100-50	1" - 50 MESH - BLUE	43.22
LST100-80	1" - 80 MESH - YELLOW	47.53
LST125-16	1 1/4" - 16 MESH-BROWNRD	94.69
LST125-30	1 1/4" - 30 MESH-FLAMERD	
LST125-50	1 1/4" - 50 MESH - BLUE	
LST125-80	1 1/4" - 80 MESH - YELLOW	
LST150-16	1 1/2" - 16 MESH - BROWNRD	94.69
LST150-30	1 1/2" - 30 MESH - FLAMERD	
LST150-50	1 1/2" - 50 MESH - BLUE	86.09
LST150-80	1 1/2" - 80 MESH - YELLOW	94.69



"Y"-TYPE LINE STRAINERS

- HEAVY DUTY GLASS REINFORCED POLYPROPYLENE
- HEAVY DUTY END CAP THREADS
- CLEAN-OUT PLUG
- 304 STAINLESS STEEL SCREENS
- EPDM GASKET. VITON AVAILABLE
- 1/2"- 1 1/4" 75 PSI, 1 1/2"-2" 150 PSI AT 70 DEGREES



<u>PART NO</u>	<u>DESCRIPTION</u>	<u>PRICE</u>
LS075-40	3/4" - 40 MESH - BROWN	40.85
LS100-40	1" - 40 MESH - BROWN	38.89
LS125-40	1 1/4" - 40 MESH - BROWN	44.95
LS150-12	1 1/2" - 12 MESH - BLACK	89.92
LS150-20	1 1/2" - 20 MESH - BEIGE	
LS150-50	1 1/2" - 50 MESH - BLUE	
LS200-06	2" - 6 MESH - WHITE	98.91
LS200-12	2" - 12 MESH - BLACK	89.92
LS200-50	2" - 50 MESH - BLUE	
LS200-80	2" - 80 MESH - YELLOW	

HOSE NOZZLE AND BALL VALVES

POLYPROPYLENE SINGLE UNION BALL VALVE

CONSTRUCTED OF ALL POLYPROPYLENE WITH NYLON SEATS AND EPDM O'RINGS. PROVIDING GOOD CHEMICAL RESISTANCE. THESE ECONOMICAL VALVES ARE FULL FLOW NON-RESTRICTED IN DESIGN AND WITHSTAND PRESSURES UP TO 100 PSI.

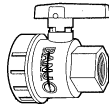

PART NO.	SIZE	PRICE
UV050FP	1/2" FPT, 3/4" PORT	23.06
UV075FP	3/4" FPT, 3/4" PORT 1"	
UV100FP	FPT, 1" PORT	28.84
UV125FP	1 1/4" FPT, 1 1/2" PORT	49.49
UV150FP	1 1/2" FPT, 1 1/2" PORT	49.15
UV200FP	2" FPT, 2" PORT	62.41

GLASS-FILLED POLYPROPYLENE BALL VALVES

PRECISION MOLDED POLYPROPYLENE IS REINFORCED WITH FIBERGLASS FOR ADDITIONAL STRENGTH. SELF ALIGNING BALL MOVES FREELY AGAINST PTFE SEATS FOR SMOOTH OPERATION. STAINLESS STEEL BOLTS. PTFE SELF LUBRICATING STEM BUSHINGS AND SEATS CANNOT BIND OR STICK. RATED AT 150 PSI.

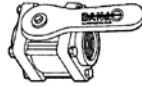

PART NO.	PORTS (NPT)	BALL OPENING	PRICE
V050	1/2"	3/4"	44.90
V075	3/4"	3/4"	
V100	1"	3/4"	
V100FP	1"	1"	49.50
V125	1 1/4"	1"	
V125FP	1 1/4"	1 1/2"	63.64
V150	1 1/2"	1 1/2"	
V200	2"	1 1/2"	
V200FP 6 BOLT	2"	2"	89.62
V204FP 4 BOLT	2"	2"	84.96
V300FP	3"	3"	214.17

ACCESSORIES

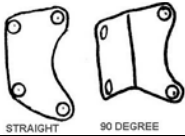

PART NO.	DESCRIPTION	FITS	PRICE
V25271	90 DEGREE MOUNTING BRACKET	V150, V200, V200FP, V300 & V300FP	22.30
V25270	STRAIGHT MOUNTING BRACKET	V150, V200, V200FP, V300 & V300FP	19.03
V10270	STRAIGHT MOUNTING BRACKET	V100FP, V125	39.84
V10271	90 DEGREE MOUNTING BRACKET	V100FP, V125	

BALL VALVE HOSE NOZZLE

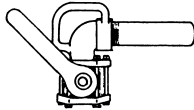

PART NO.	PORTS (NPT)	BALL OPENING	SPOUT LENGTH 8"	PRICE
VA150	1 1/2"	1 1/2"	8"	76.61
VA200	2"	1 1/2"	8"	
VA200FP	2"	2 1/16"	8"	114.62

3 WAY POLY BALL VALVES

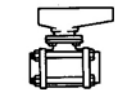

PART NO.	MAX PSI	# OF OUTLETS	CONNECTION SIZE	PRICE
AA344M-3-3/4-PP	12	2	3/4" NPT	65.69
AA344M-3-1-PP	5	2	1"	
	125			



PART NO.	DESCRIPTION	MAX PSI	PIPE SIZE	OPENING THRU BALL	PRICE
V150BL	1 1/2" BOTTOM LOAD	100	1 1/2"	1 1/2"	100.77
V200BL	2" BOTTOM LOAD	100	2"	2"	127.93



V150SL	1 1/2" SIDE LOAD 2"	100	1 1/2"	1 1/2"	100.77
V200SL	SIDE LOAD	100	2"	2"	127.93

SHUT OFF VALVE



PART NO.	DESCRIPTION	PRICE
LA24	2 WAY 3/4" FGHT X MGHT	7.01



PART NO.	DESCRIPTION	PRICE
RS-631	3/4" NPT BRASS VALVE	17.60

CHROME BALL VALVE



PART NO.	DESCRIPTION	PRICE
90FMB14	1/4" MPT X 1/4" FPT	12.85
90FMB38	3/8" MPT X 3/8" FPT	
90FMB12	1/2" MPT X 1/2" FPT	17.98
90FFB38	3/8" X 3/8" FPT	12.85
90FFB12	1/2" X 1/2" FPT	16.85



PART NO.	DESCRIPTION	PRICE
15-14	1/4" FNPT x 1/4" FNPT	14.02

STAINLESS STEEL BALL VALVES

MANUFACTURED FROM 316 STAINLESS
STEEL, 1000 PSI



<u>PART NO.</u>	<u>DESCRIPTION</u>	<u>PRICE</u>
88-38	3/8" FULL PORT	36.20
88-12	1/2" FULL PORT	39.55
60482	3/4" FULL PORT	47.96
60483	1" FULL PORT	66.15
60485	1 1/2" FULL PORT	144.33
60487	2" FULL PORT	210.32

BRASS BALL VALVES



<u>PART NO.</u>	<u>DESCRIPTION</u>	<u>PRICE</u>
7010101	1/4" F X F	11.90
7010201	3/8" F X F	11.40
7010301	1/2" F X F	16.70
7010401	3/4" F X F	21.70
7010501	1" F X F	36.95
7010601	1 1/4" F X F	66.20
7010701	1 1/2" F X F	90.60
7080101	1/4" M X F	38.25
7080201	3/8" M X F	38.25
7080301	1/2" M X F	
7080401	3/4" M X F	51.50
7080501	1" M X F	74.10
7080601	1 1/4" M X F	102.80
BBV-200	2" M X F	114.95
70802-A2	3/8" M X F (WHITE HANDLE)	31.50
70604-A2	3/4" 3 WAY BLUE HANDLE	69.00
7060501	1" 3 WAY BV	105.50
7060601	1 1/4" 3 WAY BV	144.45
7060701	1 1/2" 3 WAY BV	194.70

600 PSI
ADJUSTABLE STEM PACKING TEFLON
SEALS AND SEATS





POLYPROPYLENE CAM LEVER COUPLINGS

PART NO.	FEMALE THREAD ADAPTER	PRICE
050A	1/2"	7.12
075A	3/4"	
100A	1"	5.94
125A	1 1/4"	
150A	1 1/2"	6.74
200A	2"	7.95
300A	3"	19.21



MALE THREAD ADAPTER

050B	1/2"	16.29
075B	3/4"	
100B	1"	15.60
125B	1 1/4"	
150B	1 1/2"	18.29
200B	2"	22.27
300B	3"	37.42



HOSE SHANK COUPLER

050C	1/2"	13.58
075C	3/4"	
100C	1"	15.60
125C	1 1/4"	
150C	1 1/2"	18.29
200C	2"	22.27
300C	3"	37.42



FEMALE THREAD COUPLER

050D	1/2"	13.58
075D	3/4"	
100D	1"	15.60
125D	1 1/4"	
150D	1 1/2"	18.29
200D	2"	22.27
300D	3"	37.42



HOSE SHANK ADAPTER

050E	1/2"	6.42
075E	3/4"	
100E	1"	7.13
125E	1 1/4"	
150E	1 1/2"	7.15
200E	2"	9.38
300E	3"	24.61



MALE THREAD COUPLER

050F	1/2"	6.42
075F	3/4"	
100F	1"	7.13
125F	1 1/4"	
150F	1 1/2"	7.15
200F	2"	9.38
300F	3"	24.61



PART NO.	HOSE END CAP	PRICE
075CAP	3/4"	13.58
100125CAP	1" & 1 1/4"	14.98
150CAP	1 1/2"	18.29
200CAP	2"	22.27
300CAP	3"	37.42



COUPLER PLUG

075PL	3/4"	6.16
100125PL	1" & 1 1/4"	
150PL	1 1/2"	8.27
200PL	2"	9.31
300PL	3"	19.51



COUPLING REPLACEMENT GASKET

EPDM MATERIAL		PRICE
075G	1/2" & 3/4"	1.07
100G	1" & 1 1/4"	
150G	1 1/2"	1.14
200G	2"	1.20
300G	3"	1.64

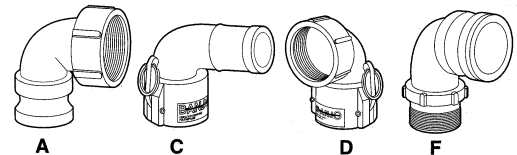

1 1/2" 90 DEGREE POLY COUPLER & ADAPTER

150A90	MALE ADAPTER 1 1/2" FEMALE THREAD	12.76
150C90	FEMALE COUPLER 1 1/2" HOSE SHANK	26.29
150D90	FEMALE COUPLER 1 1/2" FEMALE THREAD	
150F90	MALE ADAPTER 1 1/2" MALE THREAD	15.29

2" 90 DEGREE POLY COUPLER & ADAPTER

200A90	MALE ADAPTER 2" FEMALE THREAD	14.56
200C90	FEMALE COUPLER 2" HOSE SHANK	27.16
200D90	FEMALE COUPLER 2" FEMALE THREAD	
200F90	MALE ADAPTER 2" MALE THREAD	13.67

POLY SWITCH-A-ROO

75A1/4	3/4 MALE ADAPTER 1/4" F THREAD	7.12
75A3/4	3/4 MALE ADAPTER 3/4" F THREAD	5.94
75B3/4	3/4 FEMALE COUPLER 3/4" M THREAD	13.58

SPRAYER HOSE - 10% DISCOUNT FOR FULL LENGTH QUANTITY STANDARD HOSE (ROLL)



STANDARD EPDM WATER, AIR AND SPRAY HOSE; SMOOTH EPDM TUBE AND COVER; EXCELLENT OZONE AND AGING RESISTANCE; REINFORCED WITH 2 SPIRAL POLYESTER YARN; BLACK COVER.

PART NUMBER	HOSE I.D.	PRESSURE	SPIRALS	LENGTH	PPF
HST-014	1/4"	200	2	500'	0.55
HST-038	3/8"	200	2	500'	0.60
HST-012	1/2"	200	2	500'	0.90
HST-058	5/8"	200	2	500'	1.15
HST-034	3/4"	200	2	500'	1.35
HST-100	1"	200	4	500'	1.85
HST-114	1 1/4"	150	4	250'	4.00
HST-112	1 1/2"	150	4	200'	5.25
HST-200	2"	150	4	300'	6.60

DELUXE HOSE

SAME AS STANDARD HOSE EXCEPT REINFORCED WITH 4 SPIRAL POLYESTER YARN FOR HIGHER PRESSURES.

PART NUMBER	HOSE I.D.	PRESSURE	SPIRALS	LENGTH	PPF
HDX-038	3/8"	300	4	500'	0.90
HDX-012	1/2"	300	4	500'	1.25
HDX-034	3/4"	300	4	500'	1.70
HDX-100	1"	300	4	500'	2.65

PVC AG-SPRAY HOSE

HIGH PRESSURE HOSE FOR USE WITH FERTILIZER, HERBICIDES, INSECTICIDES IN AGRICULTURE, LAWN CARE AND PEST CONTROL INDUSTRIES.

PART NUMBER	HOSE I.D.	PRESSURE	LENGTH	PPF
HAS-038-6-P	3/8" YELLOW	600	300'	1.35
HAS-038-6/P-400	3/8"	600	400'	1.35
HAS-012-6-P	1/2"	600	300'	1.75
HAS-012-6/P-400	1/2"	600	400'	1.75
HAS-034-6-P	3/4"	600	300'	3.75
HAS-038-8-P	3/8" GREEN	800	300'	1.65
HAS-012-8-P	1/2"	800	300'	2.30
HAS-034-8-P	3/4"	800	300'	5.60

PVC SUCTION HOSE

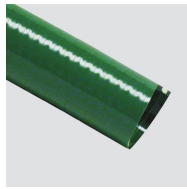

A VERSATILE, ALL-PLASTIC HOSE FOR GENERAL PUMPING SERVICE. BOTH THE COVER AND THE HELIX REINFORCEMENT ARE DURABLE PVC, PROVIDING PROTECTION AGAINST ABRASION AND CHEMICAL ACTION OF MATERIALS. GREEN OR CLEAR IN COLOR.

PART NO.	HOSE I.D.	LENGTH	PSI	PPF
HPVC-034	3/4"	100'	100	0.95
HPVC-100	1"	100'	90	1.10
HPVC-114	1 1/4"	100'	70	1.35
HPVC-112	1 1/2"	100'	70	1.60
HPVC-200	2"	100'	60	2.90
HPVC-300	3"	100'	50	5.20

PVC EPDM RUBBER SUCTION HOSE

EPDM RUBBER SUCTION HOSE WITH POLYETHYLENE HELIX HIGH IN CHEMICAL RESISTANCE EXCELLENT COLD WEATHER FLEXIBILITY. USUALLY BLACK AND YELLOW (BUMBLE BEE)

PART NO.	HOSE I.D.	PSI	LENGTH	PPF
HRS-100	1"	80	100'	2.25
HRS-114	1 1/4"	70	100'	2.60
HRS-112	1 1/2"	60	100'	2.95
HRS-200	2"	60	100'	3.85
HRS-300	3"	50	100'	8.35

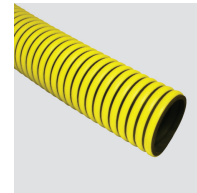

ENFORCER-REINFORCED FERTILIZER SOLUTION HOSE

A REINFORCED, FLEXIBLE, SUCTION/DISCHARGE HOSE FOR THE AGRICULTURAL AND CONSTRUCTION INDUSTRIES. HOSE IS RESISTANT TO DILUTED HERBICIDES & PESTICIDES AND HAS GOOD FLEXIBILITY IN SUB-ZERO WEATHER.

PART NO.	HOSE I.D.	PSI	LENGTH	PPF
HEN-114	1 1/4"	100	100'	3.80
HEN-112	1 1/2"	100	100'	4.15
HEN-200	2"	100	100'	5.35
HEN-300	3"	85	100'	9.40

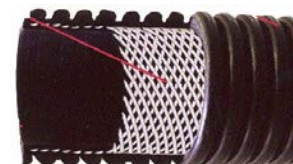

WIRE REINFORCED SUCTION HOSE

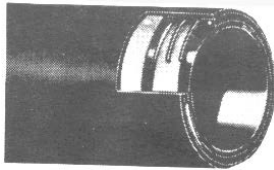

A HIGH QUALITY HOSE THAT HANDLES MOST FARM CHEMICALS IN A VARIETY OF AGRICULTURAL APPLICATIONS. EPDM TUBE REINFORCED WITH SYNTHETIC CORD AND SPIRAL HELIX WIRE FOR FLEXIBILITY AND CRUSH RESISTANCE. EPDM COVER IS RESISTANT TO ABRASION AND ROUGH HANDLING CONDITIONS.

PART NO.	SIZE I.D.	PSI	LENGTH	PPF
HWR-100	1"	150	100'	6.65
HWR-114	1 1/4"	150	100'	5.20
HWR-112	1 1/2"	150	100'	5.45
HWR-200	2"	120	100'	6.90
HWR-300	3"	100	100'	8.95

LAY FLAT PVC DISCHARGE HOSE (BLUE)

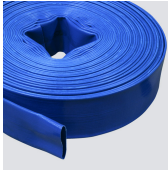

PART NO.	SIZE I.D.	PRESSURE	LENGTH	PPF
HLF-114	1 1/4"	80	300'	1.05
HLF-112	1 1/2"	75	300'	0.60
HLF-200	2"	70	300'	0.75

A LOW TO MEDIUM PRESSURE HOSE FOR IRRIGATION. TUBE AND COVER ARE PVC AND REINFORCEMENT IS A SPIRAL OF HIGH GRADE CORD FABRIC. RESISTANT TO OILS, GREASE AND MANY CHEMICALS AND ACIDS. NON-WATER ABSORBING, MILDEW-PROOF.

EVA SOLUTION TUBING

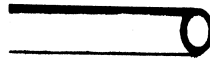

FOR LIQUID FERTILIZER AND CHEMICAL APPLICATOR, SPRAYER, AND TRANSFER SERVICE. ETHYL VINYL ACETATE PLASTIC TUBING. USED IN APPLYING ANHYDROUS AMONONIA, HERBICIDES, INSECTICIDES, PHOSPHATES AND ALL LIQUID FERTILIZERS.

PART NO.	SIZE I.D.	WORKING PRESSURE AT		LENGTH	PPF
		110 DEGREES F			
HSL-038	3/8"	45 PSI	500'	0.45	
HSL-012	1/2"	45PSI	500'	0.55	
HSL-034	3/4"	45 PSI	250'	0.95	
HSL-100	1"	35 PSI	200'	1.20	

CLEAR SIGHT GAUGE TUBING

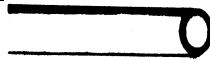

FOR GAUGE GLASS, LIQUID LEVEL, LOW TEMPERATURE AND CHEMICAL SERVICE. NOT RECOMMENDED FOR VACUUM SERVICE.

PART NO.	SIZE I.D.	WORKING PRESSURE AT		LENGTH	PPF
		110 DEGREES F			
HSG-014	1/4"	NOT RECOMMENDED	100'	0.40	
HSG-038	3/8"	NOT RECOMMENDED	100'	0.65	
HSG-012	1/2"	NOT RECOMMENDED	100'	0.90	
HSG-034	3/4"	NOT RECOMMENDED	100'	1.20	
HSG-100	1"	NOT RECOMMENDED	100'	1.45	

POLYETHYLENE TUBING

PART NO.	SIZE	LENGTH	PPF
HPL-018	1/4" O.D. X 1/8" I.D.	100	0.15
HPL-014	3/8" O.D. x 1/4" I.D.	100'	0.28
HPL-038	1/2" O.D. x 3/8" I.D.	100'	0.34
HPL-012	5/8" O.D. x 1/2" I.D.	100'	0.38
HPL-058	3/4" O.D. x 5/8" I.D.	100'	0.45
HPL-034	1" O.D. x 3/4" I.D.	100'	1.28

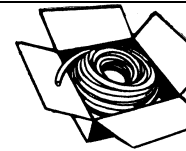

USED FOR FUMIGANT APPLICATION

REINFORCED VINYL TUBING

APPLICATION: FOR USE WHEN A CLEAR HOSE IS REQUIRED THAT NEEDS A HIGHER WORKING PRESSURE THAN NON-REINFORCED VINYL TUBING SUCH AS AIR, WATER, AND PNEUMATIC LINES. **CONSTRUCTION:** CRYSTAL CLEAR POLYVINYL CHLORIDE REINFORCED WITH A SYNTHETIC CORD.



PART NO.	SIZE	PRESSURE	LENGTH	PPF
HBR-014	1/4"	250	300'	0.45
HBR-038	3/8"	225	300'	0.60
HBR-012	1/2"	200	300'	0.75
HBR-034	3/4"	150	300'	1.15
HBR-100	1"	125	200'	1.70

HANNAY HOSE REELS

REWIND: CHOOSE DIRECT-CRANK REWIND (CRANK IS PERMANENTLY) OR CHAIN AND SPROCKET DRIVE POWERED BY ELECTRIC MOTOR

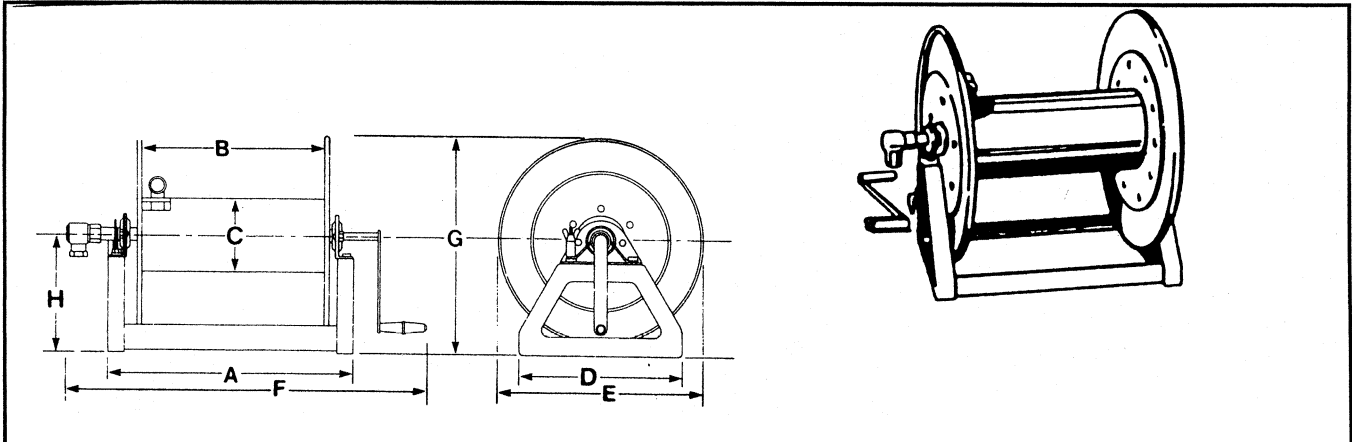

HOSE CAPACITY OF REEL IN FEET				MODEL NUMBER		REEL DIMENSIONS IN INCHES E, F, AND G ARE OVERALL DIMENSIONS									
I.D.	3/8"	1/2"	3/4"	A	B	C	D	E	E	F	F	INLET	OUTLET	G	H
O.D.	5/8"	7/8"	1 1/8"					CRANK	ELEC.	CRANK	ELEC.				
425	300	200		1520-17-18	17	12	6 1/4	14	16 1/2	19	24 1/2	22 1/2	1/2	1/2	18 9 7/8
625	450	325		1526-17-18	23	18	6 1/4	14	16 1/2	19	30 1/2	28 1/2	1/2	1/2	18 9 7/8
			150	1826-17-18	23	18	6 1/4	14	16 1/2	19	31 3/4	28 1/2	1	3/4	18 9 7/8
200	150	100		1514-17-18	11	6	6	14	16 1/2	19		16 1/2	1/2	1/2	18 9 7/8
		50		N716-19-20JTR	9 1/4	4	10 1/2	18					1/2	1/2	19 3/4 10 3/8

PART NO.	DESCRIPTION	PRICE	PART NO.	DESCRIPTION	PRICE
1514-17-18	6" MANUAL REEL 3000 PSI	399.00			
1520-17-18	12" MANUAL REEL 3000 PSI	399.00	E1520-17-18	12" ELECTRIC REEL - 12V MOTOR	931.00
1526-17-18	18" MANUAL REEL 3000 PSI	399.00	E1526-17-18	18" ELECTRIC REEL - 12V MOTOR	931.00
1826-17-18	18" MANUAL REEL 1000 PSI	483.00	E1826-17-18	18" ELECTRIC REEL - 12V MOTOR	1015.00
27.8551	1/2" SWIVEL ASSEMBLY	70.88	36.0389	REPAIR KIT	34.65
29.8552	1" SWIVEL ASSEMBLY	129.15	36.0321	OLD REPAIR KIT	81.90



TOP WIND HOSE ROLLER AND SPOOL ASSY MOUNTING BRACKET FOR 1500 SERIES REELS SS ROLLERS. OTHER SIZES AVAILABLE. SHOWN ON 1500 REEL.
FH-312-CPT
 ROLLER AND SPOOL FOR 1520-17-18 **310.28**
FH-318-CPT
 ROLLER AND SPOOL FOR 1526-17-18 **310.28**



PRESSURE PRO HOSE REEL
 DIRECT HAND-CRANK REWIND
 SOLID STEEL CONSTRUCTION
 DURABLE POWDER COAT FINISH
 FULL FLOW SWIVEL BRASS JOINT
 MAXIMUM TEMPERATURE RATING 225 DEGREES F

PART NO.	3/8 CAPACITY	PSI	PRICE
D30001	50'	3500	96.73
D30002	100'	3500	136.69
D30006	150'	3500	199.50

100055-HANDLE D30001 2100278-REPAIR KIT
 2103241-SWIVEL D30001 2103240-D30004

SS HOSE CLAMPS

ALL SS BAND, SCREW AND HOUSING

PART NO.	FITS HOSE SIZE	PRICE
B6HS	3/8"-1/2"	.93
B12HS	3/4"	1.30
B16HS	1"	1.34
B20HS	1 1/4"	1.41
B24HS	1 1/2"	1.51
B28HS	1 3/4"	1.54
B36HS	2 1/4"	1.69
B52HS	2 1/2"	2.39
B56HS	3"	2.64
M4S(MINI)	5/16"	0.93
M6S(MINI)	3/8 & 1/2"	0.93

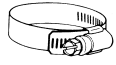

BANJO SUPER CLAMPS

PART NO.	SIZE	PRICE
TC130	1 1/4"	10.82
TC162	1 1/4"	9.92
TC181	1 1/2"	
TC193	1 1/2"	10.20
TC218	2"	
TC224	2"	11.44
TC231	2"	10.40
TC250	2"	11.44
TC312	3"	11.70
TC343	3"	11.11



SS CONSTRUCTION, SS BOLT WITH SILVER PLATED NUT TO PREVENT SEIZING, NYLON LOCK NUT FEATURE, T-BOLT DESIGN, AND 3 SPOT WELDS FOR EXTRA STRENGTH.

NYLON FITTINGS

**HOSE FITTING:
ADAPTOR-
MALE TAPER
PIPE THREAD BY
HOSE BARB**

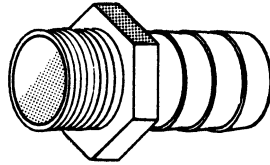

<u>PART NO.</u>	<u>THREAD</u>	<u>BARB</u>	<u>PRICE</u>
A1814	1/8	1/4	0.45
A1812	1/8	1/2	0.50
A1838	1/8	3/8	0.46
A1414	1/4	1/4	0.45
A1438	1/4	3/8	0.46
A1412	1/4	1/2	0.49
A3814	3/8	1/4	0.47
A3838	3/8	3/8	0.48
A3812	3/8	1/2	0.49
A3858	3/8	5/8	0.49
A3834	3/8	3/4	0.60
A1214	1/2	1/4	0.52
A1238	1/2	3/8	0.52
A1212	1/2	1/2	0.54
A1258	1/2	5/8	0.58
A1234	1/2	3/4	0.67
A1210	1/2	1	0.89
A3414	3/4	1/4	0.83
A3438	3/4	3/8	0.60
A3412	3/4	1/2	0.61
A3458	3/4	5/8	0.99
A3434	3/4	3/4	0.67
A3410	3/4	1	0.83
A1012	1	1/2	0.83
A1034	1	3/4	0.86
A1010	1	1	0.96
A1-114	1	1 1/4	1.96
A114-34	1 1/4	3/4	2.80
A114-1	1 1/4	1	2.10
A114	1 1/4	1 1/4	1.96
A114-112	1 1/4	1 1/2	2.17
A112-114	1 1/2	1 1/4	2.29
A112	1 1/2	1 1/2	2.18
A112-200	1 1/2	2	6.79
A200	2	2	2.94
A200-112	2	1 1/2	5.76

**CONVERSION CHART
MALE PIPE THREAD TO INCHES**

<u>NPT</u>	<u>APPROXIMATE MEASUREMENT IN INCHES</u>
1/4"	1/2"
3/8"	5/8"
1/2"	3/4"
3/4"	1"
1"	1 1/4"
1 1/4"	1 5/8"
1 1/2"	1 7/8"
2"	2 3/8"
2 1/2"	2 7/8"
3"	3 7/16"
4"	4 1/2"

**GARDEN HOSE:
SWIVEL NUT - FLAT
SEAT HOSE BARB**



<u>PART NO.</u>	<u>THREAD</u>	<u>BARB</u>	<u>PRICE</u>
C1400	3/4 FGHT	1/4	1.00
C3800	3/4 FGHT	3/8	1.00
C1200	3/4 FGHT	1/2	1.00
C5800	3/4 FGHT	5/8	1.00
C3400	3/4 FGHT	3/4	1.00

ABOVE PRICES ARE FOR COMPLETE ASSEMBLY-SWIVEL GARDEN HOSE THREAD NUT, WASHER AND BARB.

C1400B	1/4 BARB ONLY		0.47
C3800B	3/8" BARB ONLY		0.47
C1200B	1/2" BARB ONLY		0.47
C5800B	5/8" BARB ONLY		0.45
C3400B	3/4" BARB ONLY		0.51
B3400	SWIVEL NUT ONLY - 3/4" FGHT		0.51
W406	POLYETHYLENE WASHER (3/4" NUT)		0.12

**GARDEN HOSE:
MALE GARDEN
HOSE THREAD BY
HOSE BARB**

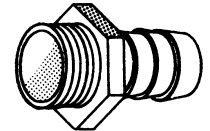

<u>PART NO.</u>	<u>THREAD</u>	<u>BARB</u>	<u>PRICE</u>
D3414	3/4 MGHT	1/4	0.64
D3438	3/4 MGHT	3/8	0.66
D3412	3/4 MGHT	1/2	0.67
D3458	3/4 MGHT	5/8	0.70
D3434	3/4 MGHT	3/4	0.76
D3410	3/4 MGHT	1	0.83

**GARDEN HOSE:
ADAPTOR-
MALE GARDEN HOSE
BY MALE PIPE THREAD**

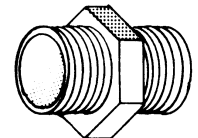

<u>PART NO.</u>	<u>THREAD</u>	<u>THREAD</u>	<u>PRICE</u>
E3438	3/4 MGHT	3/8 MPT	1.22
E3412	3/4 MGHT	1/2 MPT	0.68
E3434	3/4 MGHT	3/4 MPT	0.67

**HOSE FITTING:
ELBOW-FEMALE
PIPE THREAD BY
HOSE BARB**

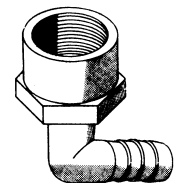

<u>PART NO.</u>	<u>THREAD</u>	<u>BARB</u>	<u>PRICE</u>
EL1212F	1/2" FPT	1/2	1.20
EL3412F	3/4" FPT	1/2	1.20
EL3434F	3/4" FPT	3/4	1.46

NYLON FITTINGS

**HOSE FITTING:
ELBOW- MALE
TAPER PIPE
BY HOSE
BARB**

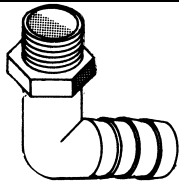

PART NO.	THREAD	BARB	PRICE
EL1814	1/8	1/4	0.60
EL1414	1/4	1/4	0.58
EL1438	1/4	3/8	0.59
EL1412	1/4	1/2	0.66
EL3814	3/8	1/4	0.70
EL3838	3/8	3/8	0.74
EL3812	3/8	1/2	0.74
EL1238	1/2	3/8	0.77
EL1212	1/2	1/2	0.78
EL1258	1/2	5/8	0.97
EL1234	1/2	3/4	1.03
EL3414	3/4	1/4	1.65
EL3438	3/4	3/8	0.89
EL3412	3/4	1/2	0.93
EL3458	3/4	5/8	0.99
EL3434	3/4	3/4	1.07
EL3410	3/4	1	1.10
EL1012	1	1/2	1.04
EL1034	1	3/4	1.18
EL1010	1	1	1.28
EL114-34	1 1/4	3/4	2.55
EL114-1	1 1/4	1	2.22
EL114	1 1/4	1 1/4	2.38
EL112	1 1/2	1 1/2	3.06
EL200	2	2	4.04

**GARDEN HOSE:
ELBOW-MALE
GARDEN HOSE
BY MALE PIPE**

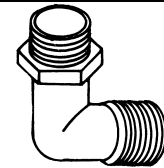

PART NO.	THREAD	THREAD	PRICE
EL3412GP	3/4 MGHT	1/2 MPT	0.90
EL3434GP	3/4 MGHT	3/4 MPT	1.04

**HOSE FITTING:
ELBOW-HOSE
BARB BY
HOSE BARB**

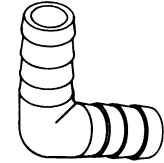

PART NO.	BARB	BARB	PRICE
EL14HB	1/4	1/4	1.08
EL38HB	3/8	3/8	0.98
EL12HB	1/2	1/2	0.70
EL58HB	5/8	5/8	1.13
EL34HB	3/4	3/4	0.89
EL100HB	1	1	2.54
EL114HB	1 1/4	1 1/4	3.60
EL112HB	1 1/2	1 1/2	3.60
EL200HB	2	2	7.16

**PIPE FITTING:
ELBOW-FEMALE
PIPE BY
FEMALE PIPE**



PART NO.	THREAD	THREAD	PRICE
ELF12	1/2 FPT	1/2 FPT	2.66
ELF34	3/4 FPT	3/4 FPT	3.01
ELF100	1 FPT	1 FPT	4.28
ELF114	1 1/4 FPT	1 1/4 FPT	5.80
ELF112	1 1/2 FPT	1 1/2 FPT	6.90
ELF200	2 FPT	2 FPT	10.11

**PIPE FITTING:
HEX HEAD
PIPE PLUG**

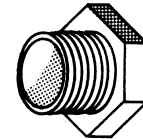

PART NO.	THREAD	PRICE
F1800	1/8	0.54
F1400	1/4	0.60
F3800	3/8	0.63
F1200	1/2	0.63
F3400	3/4	0.66
F1000	1	0.69
F114	1 1/4	1.04
F112	1 1/2	2.91
F200	2	3.55

HOSE SAVER STRAIGHT ASSEMBLY



PART NO.	THREAD X BARB	PRICE
626320N	3/4 MPT X 3/4	6.99
626325N	3/4 MPT X 1	8.23
626425N	1 MPT X 1	8.03
626525N	1 1/4 MPT X 1	9.580
626532N	1 1/4 MPT X 1 1/4	9.71
626632N	1 1/2 MPT X 1 1/4	10.13
626638N	1 1/2 MPT X 1 1/2	12.24

HOSE SAVER ELBOW ASSEMBLY



PART NO.	THREAD X BARB	PRICE
627320N	3/4 MPT X 3/4	7.79
627325N	3/4 MPT X 1	9.58
627420N	1 MPT X 3/4	7.79
627425N	1 MPT X 1	9.58
627632N	1 1/2 MPT X 1 1/4	13.60
627638N	1 1/2 MPT X 1 1/2	18.53

**PIPE FITTING:
COUPLING-
FEMALE PIPE BY
FEMALE PIPE**

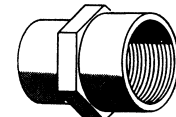

PART NO.	THREAD	THREAD	PRICE
FC14	1/4 FPT	1/4 FPT	4.04
FC38	3/8 FPT	3/8 FPT	4.04
FC12	1/2 FPT	1/2 FPT	2.80
FC34	3/4 FPT	3/4 FPT	3.41
FC100	1 FPT	1 FPT	3.87
FC114	1 1/4 FPT	1 1/4 FPT	5.44
FC112	1 1/2 FPT	1 1/2 FPT	6.49
FC200	2 FPT	2 FPT	9.57

NYLON FITTINGS

NOZZLE FITTING: FLOOD TIP ADAPTER

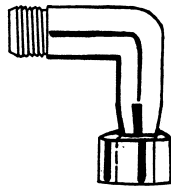

<u>PART NO.</u>	<u>THREAD</u>	<u>PRICE</u>
FTA11-16	1 1/16 MPS	2.88

PIPE FITTING: NIPPLE - MALE PIPE BY MALE PIPE

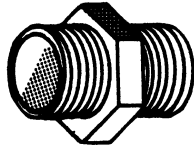

<u>PART NO.</u>	<u>THREAD</u>	<u>THREAD</u>	<u>PRICE</u>
M1800	1/8	1/8	0.65
M1400	1/4	1/4	0.60
M3800	3/8	3/8	0.63
M1200	1/2	1/2	0.64
M3400	3/4	3/4	0.69
M100	1	1	1.11
M114	1 1/4	1 1/4	2.08
M112	1 1/2	1 1/2	2.52
M200	2	2	3.62

GARDEN HOSE: CAP - KNURLED WITH WASHER

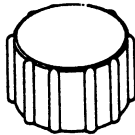

<u>PART NO.</u>	<u>THREAD</u>	<u>PRICE</u>
N3400	3/4 FGHT	0.74

SWIVEL FITTINGS FOR SHURFLO PUMPS



SWIVEL HEX WINGNUT
STRAIGHT

<u>PART NO.</u>	<u>DESCRIPTION</u>	<u>PRICE</u>
234-2926	1/2"NPT FEMALE x 1/2" BARB	1.32
234-2916	1/2"NPT FEMALE X 3/8" BARB	1.40



SWIVEL HEXNUT ELBOW

234-3926	1/2"NPT FEMALE X 1/2" BARB SWIVEL HEXNUT ELBOW	1.32
234-3916	1/2"NPT FEMALE X 3/8"BARB SWIVEL HEXNUT ELBOW	1.32

PIPE FITTING: STREET ELBOW

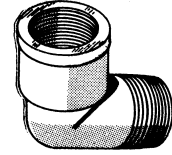

<u>PART NO.</u>	<u>THREAD</u>	<u>THREAD</u>	<u>PRICE</u>
SE38	3/8 FPT	3/8 MPT	2.82
SE14	1/4 FPT	1/4 MPT	2.76
SE12	1/2 FPT	1/2 MPT	2.88
SE34	3/4 FPT	3/4 MPT	3.33
SE100	1 FPT	1 MPT	4.69
SE114	1 1/4 FPT	1 1/4 MPT	6.00
SE112	1 1/2 FPT	1 1/2 MPT	7.38
SE200	2 FPT	2 MPT	8.42

PIPE FITTING: REDUCER BUSHING

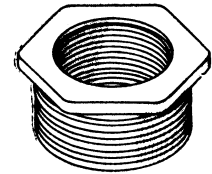

<u>PART NO.</u>	<u>THREAD</u>	<u>THREAD</u>	<u>PRICE</u>
RB14-18	1/4 MPT	1/8 FPT	0.84
RB38-18	3/8 MPT	1/8 FPT	0.87
RB38-14	3/8 MPT	1/4 FPT	0.84
RB12-14	1/2 MPT	1/4 FPT	0.90
RB12-38	1/2 MPT	3/8 FPT	0.88
RB34-18	3/4 MPT	1/8 FPT	0.97
RB34-14	3/4 MPT	1/4 FPT	1.16
RB34-38	3/4 MPT	3/8 FPT	1.23
RB34-12	3/4 MPT	1/2 FPT	0.90
RB10-12	1 MPT	1/2 FPT	1.62
RB10-34	1 MPT	3/4 FPT	1.11
RB114-34	1 1/4 MPT	3/4 FPT	2.01
RB114-1	1 1/4 MPT	1 FPT	1.91
RB112-34	1 1/2 MPT	3/4 FPT	2.21
RB112-1	1 1/2 MPT	1 FPT	2.17
RB112-114	1 1/2 MPT	1 1/4 FPT	1.93
RB200-100	2 MPT	1 FPT	3.86
RB200-114	2 MPT	1 1/4 FPT	2.94
RB200-112	2MPT	1 1/2 FPT	2.66
RB300-200	3 MPT	2 FPT	4.73

HOSE FITTING ADAPTOR: FEMALE TAPER PIPE THREAD BY HOSE BARB

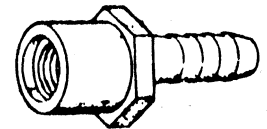

<u>PART NO.</u>	<u>THREAD</u>	<u>BARB</u>	<u>PRICE</u>
AF1414	1/4	1/4	1.41
AF1438	1/4	3/8	3.33
AF1412	1/4	1/2	2.93
AF3838	3/8	3/8	3.80
AF1238	1/2	3/8	1.16
AF1212	1/2	1/2	1.14

NYLON FITTINGS

**PIPE FITTING:
STREET ELBOW
45 DEGREE**

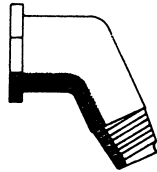

<u>PART NO.</u>	<u>THREAD</u>	<u>THREAD</u>	<u>PRICE</u>
SEQ1414	1/4 FPT	1/4 MPT	2.31
SEQ3412	3/4 FPT	1/2 MPT	5.36

**HOSE FITTING:
HOSE MENDER -
BARB TO BARB**

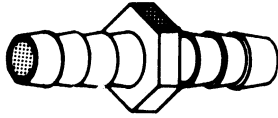

<u>PART NO.</u>	<u>BARB</u>	<u>BARB</u>	<u>PRICE</u>
SHM1800	1/8	1/8	0.50
SHM1400	1/4	1/4	0.44
SHM3800	3/8	3/8	0.49
SHM3814	3/8	1/4	0.61
SHM1200	1/2	1/2	0.62
SHM1238	1/2	3/8	0.50
SHM1258	1/2	5/8	0.70
SHM5800	5/8	5/8	0.70
SHM3400	3/4	3/4	0.77
SHM1000	1	1	0.92
SHM114	1 1/4	1 1/4	1.50
SHM112	1 1/2	1 1/2	3.65
SHM200	2	2	6.12

**HOSE FITTING:
TEE -
BARBED**

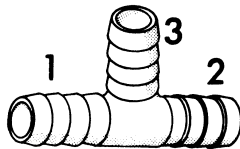

<u>PART NO.</u>	<u>BARB SIZE</u>			<u>PRICE</u>
	<u>1</u>	<u>2</u>	<u>3</u>	
T18	1/8	1/8	1/8	1.16
T14	1/4	1/4	1/4	0.87
T38	3/8	3/8	3/8	0.91
T3812	1/2	1/2	3/8	0.95
T12	1/2	1/2	1/2	0.94
T58	5/8	5/8	5/8	1.00
T3412	1/2	1/2	3/4	1.00
T34	3/4	3/4	3/4	1.19
T100	1	1	1	2.08
T114	1 1/4	1 1/4	1 1/4	3.03
T112	1 1/2	1 1/2	1 1/2	3.69
T200	2	2	2	8.31

**PIPE FITTING:
TEE - FEMALE**

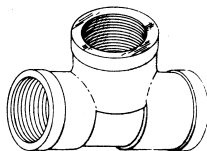

<u>PART NO.</u>	<u>THREAD</u>	<u>PRICE</u>
TT14	1/4 FPT	3.54
TT12	1/2 FPT	3.38
TT34	3/4 FPT	4.71
TT100	1 FPT	5.99
TT114	1 1/4 FPT	8.22
TT112	1 1/2 FPT	9.24
TT200	2 FPT	12.63

POLYPROPYLENE PIPE FITTINGS







HOSE BARBS



<u>PART NO.</u>	<u>SIZE</u>	<u>PRICE</u>
HB025-038	1/4" X 3/8" HB 1/2" x HB	1.54
HB050	1/2" X HB	1.39
HB075	3/4" X HB	1.53
HB075-050	3/4" x 1/2" HB	1.85
HB075-100	3/4" x 1" HB	2.25
HB100	1" x HB	1.89
HB100-075	1" X 3/4" HB	2.25
HB100-125	1" X 1 1/4" HB	2.78
HB125-100	1 1/4" x 1" HB	2.78
HB125-150	1 1/4" x 1 1/2" HB	5.31
HB125	1 1/4" x HB	2.78
HB150	1 1/2" x HB	3.88
HB150-100	1 1/2" X 1" HB	4.16
HB150-125	1 1/2" X 1 1/4" HB	
HB150-200	1 1/2" x 2" HB	7.15
HB200-150	2" x 1 1/2" HB	5.96
HB200	2" x HB	4.74
HB300	3" X HB	15.30
HB400	4" X HB	38.48

POLYPROPYLENE PIPE FITTINGS

 <p>PIPE NIPPLE</p>	PART NO.	SIZE	PRICE
	NIP050-SH	1/2" SHORT	1.84
	NIP075-SH	3/4" SHORT	1.57
	NIP075-4	3/4" X 4"	3.62
	NIP075-6	3/4" X 6"	4.25
	NIP100-SH	1" SHORT	2.13
	NIP100-4	1" X 4"	3.86
	NIP100-6	1" X 6"	4.78
	NIP125-SH	1 1/4" SHORT	2.71
	NIP125-4	1 1/4" X 4"	4.78
	NIP125-6	1 1/4" X 6"	5.44
	NIP150-SH	1 1/2" SHORT	4.15
	NIP150-4	1 1/2" x 4"	10.23
	NIP150-6	1 1/2" x 6"	12.04
	NIP200-SH	2" SHORT	4.70
NIP200-4	2" x 4"	9.90	
NIP200-6	2" x 6"	11.56	
NIP300-SH	3" SHORT	14.73	
NIP300-4	3" x 4"	22.12	
NIP300-6	3" x 6"	28.51	
 <p>REDUCER BUSHING</p>	PART NO.	SIZE MPT X FPT	PRICE
	RB075-050-PP	3/4" X 1/2"	3.62
	RB100-075-PP	1" X 3/4"	3.20
	RB125-075-PP	1 1/4" X 3/4"	3.86
	RB125-100-PP	1 1/4" X 1"	
	RB150-075-PP	1 1/2" X 3/4"	5.10
	RB150-100-PP	1 1/2" X 1"	
	RB150-125-PP	1 1/2" X 1 1/4" 2"	
	RB200-100-PP	2" X 1"	4.61
	RB200-125-PP	2" X 1 1/4"	5.55
	RB200-150-PP	2" X 1 1/2"	4.61
	RB300-150-PP	3" X 1 1/2"	23.10
	RB300-200-PP	3" X 2"	19.25
RB400-300	4" X 3"	35.81	
 <p>REDUCER COUPLING</p>	PART NO.	SIZE	PRICE
	RC100-075	1" X 3/4"	8.21
	RC150-100	1 1/2" x 1"	13.94
	RC150-125	1 1/2" x 1 1/4"	
	RC200-100	2" x 1"	12.35
	RC200-125	2" x 1 1/4"	14.82
	RC200-150	2" x 1 1/2"	12.35
RC300-200	3" x 2"	43.84	
 <p>REDUCER NIPPLE</p>	PART NO.	SIZE	PRICE
	RN050-038	1/2" X 3/8"	2.75
	RN075-050	3/4" X 1/2"	2.95
	RN100-075	1" X 3/4"	3.46
	RN125-075	1 1/4" X 3/4"	4.00
	RN125-100	1 1/4" X 1"	3.62
	RN150-100	1 1/2" X 1"	4.28
	RN150-125	1 1/2" X 1 1/4"	3.86
RN200-150	2" X 1 1/2"	4.26	
 <p>PIPE PLUG</p>	PART NO.	SIZE	PRICE
	PLUG025	1/4"	3.82
	PLUG038	3/8"	3.82
	PLUG050	1/2"	3.86
	PLUG075	3/4"	3.86
	PLUG100	1"	
	PLUG125	1 1/4"	5.06
	PLUG150	1 1/2"	
	PLUG200	2"	5.11
	PLUG300	3"	24.18
 <p>PIPE CAP</p>	PART NO.	SIZE	PRICE
	CAP050	1/2"	7.45
	CAP075	3/4"	
	CAP100	1"	6.21
	CAP125	1 1/4"	8.36
	CAP150	1 1/2"	10.54
	CAP200	2"	12.21

 <p>CROSS</p>	PART NO.	SIZE	PRICE
	CR025	1/4"	14.49
	CR038	3/8"	15.91
	CR050	1/2"	24.64
	CR075	3/4"	
	CR100	1"	
	CR125	1 1/4"	36.73
	CR150	1 1/2"	
	CR200	2"	37.47
	 <p>PIPE COUPLING</p>	PART NO.	SIZE
CPLG025		1/4"	4.93
CPLG038		3/8"	5.54
CPLG050		1/2"	
CPLG075		3/4"	
CPLG100		1"	5.25
CPLG125		1 1/4"	8.51
CPLG150	1 1/2"	11.78	
CPLG200	2"	13.45	
CPLG300	3"	38.05	
 <p>PIPE TEE</p>	PART NO.	SIZE	PRICE
	TEE038	3/8"	5.18
	TEE050	1/2"	4.70
	TEE075	3/4"	5.04
	TEE100	1"	7.26
	TEE125	1 1/4"	10.05
	TEE150	1 1/2"	12.02
TEE200	2"	14.97	
TEE300	3"	71.32	
 <p>PIPE EL 90 DEGREE</p>	PART NO.	SIZE	PRICE
	EL050-90	1/2"	4.85
	EL075-90	3/4"	4.39
	EL100-90	1"	5.16
	EL125-90	1 1/4"	7.74
	EL150-90	1 1/2"	12.14
	EL200-90	2"	12.02
EL300-90	3"	61.12	
 <p>PIPE STREET EL 45 OR 90 DEGREE</p>	PART NO.	SIZE	PRICE
	SL050-90	1/2"	4.24
	SL075-45	3/4"	8.74
	SL075-90	3/4"	4.52
	SL100-45	1"	11.74
	SL100-90	1"	5.36
	SL125-45	1 1/4"	14.54
	SL125-90	1 1/4"	7.36
	SL150-45	1 1/2"	15.52
	SL150-90	1 1/2"	10.43
	SL200-45	2"	16.72
SL200-90	2"	12.38	
SL300-90	3"	63.03	
 <p>MALE PIPE EL X HB 90 DEGREE</p>	PART NO.	SIZE MPT X HB	PRICE
	HB050/038-90	1/2" X 3/8"HB	1.85
	HB050-90	1/2" x HB	
	HB050/075-90	1/2" x 3/4"HB	
	HB075-90	3/4" x HB	1.94
	HB075/050-90	3/4" X 1/2"HB	2.33
	HB075/100-90	3/4" x 1" HB	
	HB100-90	1" x HB	2.48
	HB100/075-90	1" X 3/4"	2.99
	HB100/125-90	1" X 1 1/4"HB	3.65
	HB125/100-90	1 1/4" x 1" HB	3.65
	HB125-90	1 1/4" x HB	
	HB125/150-90	1 1/4" X 1 1/2"HB	10.54
	HB150-90	1 1/2" x HB	8.77
	HB150/125-90	1 1/2" X 1 1/4"HB	10.54
HB200-90	2" x HB	9.61	
HB200/150-90	2" X 1 1/2" HB	11.54	
HB300-90	3" X HB	46.46	

STAINLESS STEEL FITTINGS



REDUCER BUSHING		
PART NO.	SIZE	PRICE
RB12-14-SS	1/2" x 1/4"	3.54
RB34-14-SS	3/4" X 1/4"	6.15
RB34-12-SS	3/4" x 1/2"	6.15
RB38-14-SS	3/8" X 1/4"	3.77
RB10-12-SS	1" X 1/2"	9.860
RB10-34-SS	1" x 3/4"	9.86
RB114-1-SS	1 1/4" x 1"	13.69
RB112-34-SS	1 1/2" X 3/4"	19.89
RB112-1-SS	1 1/2" X 1"	18.56
RB112-114-SS	1 1/2" x 1 1/4"	25.06
RB200-150-SS	2" x 1 1/2"	30.97



COUPLING		
PART NO.	SIZE	PRICE
CP14-SS	1/4"	4.23
CP12-SS	1/2"	7.95
CP34-SS	3/4"	11.02
CP100-SS	1"	16.41
CP114-SS	1 1/4"	24.82
CP112-SS	1 1/2"	31.15
CP200-SS	2"	53.07

REDUCER COUPLING		
PART NO.	SIZE	PRICE
RCP14-18-SS	1/4" X 1/8"	\$4.00



STREET ELBOW		
PART NO.	SIZE	PRICE
SE14-SS	1/4"	4.87
SE38-SS	3/8"	5.45
SE34-SS	3/4"	12.49
SE100-SS	1"	20.30
SE114-SS	1 1/4"	32.19
SE112-SS	1 1/2"	42.46



PART NO.	SIZE	PRICE
ELE14-SS	1/4"	4.23
ELE12-SS	1/2"	8.93
ELE34-SS	3/4"	14.62
ELE100-SS	1"	21.81
ELE114-SS	1 1/4"	34.28
ELE112-SS	1 1/2"	44.14
ELE200-SS	2"	68.15

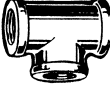

TEE		
PART NO.	SIZE	PRICE
TT14-SS	1/4"	7.83
TT12-SS	1/2"	13.05
TT34-SS	3/4"	20.53
TT100-SS	1"	31.38
TT114-SS	1 1/4"	48.14
TT112-SS	1 1/2"	60.67



CLOSE NIPPLE		
PART NO.	SIZE	PRICE
M18-SS	1/8"	2.38
M14-SS	1/4"	2.96
M38-SS	3/8"	3.77
M12-SS	1/2"	5.16
M34-SS	3/4"	6.90
M100-SS	1"	8.99
M114-SS	1 1/4"	11.54
M112-SS	1 1/2"	15.20
M200-SS	2"	21.23

STAINLESS STEEL HOSE BARBS

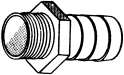

PART NO.	SIZE	PRICE
HB025-038SS	1/4" MALE THREAD x 3/8" HOSE BARB	17.64
HB025-050SS	1/4" MALE THREAD x 1/2" HOSE BARB	19.41
HB038-050SS	3/8" MALE THREAD x 1/2" HOSE BARB	19.85
HB050SS	1/2" MALE THREAD x 1/2" HOSE BARB	22.09
HB075SS	3/4" MALE THREAD x 3/4" HOSE BARB	25.81
HB100SS	1" MALE THREAD x 1" HOSE BARB	36.09
HB125SS	1 1/4" MALE THREAD x 1 1/4" HOSE BARB	54.10
HB150SS	1 1/2" MALE THREAD x 1 1/2" HOSE BARB	56.05
HB200SS	2" MALE THREAD x 2" HOSE BARB	66.24

ALUMINUM FITTINGS



COUPLING		
PART NO.	SIZE	PRICE
CP14-AL	1/4"	3.65
CP12-AL	1/2"	3.78
CP34-AL	3/4"	4.00
CP100-AL	1"	4.73
CP114-AL	1 1/4"	5.60
CP112-AL	1 1/2"	8.90
CP200-AL	2"	11.30



90 DEGREE ELBOW		
PART NO.	SIZE	PRICE
ELE14-AL	1/4"	7.70



TEE		
PART NO.	SIZE	PRICE
TT14-AL	1/4"	9.70
TT12-AL	1/2"	13.35

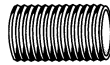

CLOSE NIPPLE		
PART NO.	SIZE	PRICE
M14-AL	1/4"	7.05
M12-AL	1/2"	6.45
M100-AL	1"	8.49

CR14-AL	1/4"	11.77
---------	------	-------

BRASS PIPE FITTINGS

90 DRAIN COCK

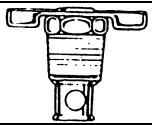

<u>PART NO.</u>	<u>PIPE SIZE</u>	<u>PRICE</u>
90-2	1/8"	3.00
90-4	1/4"	3.63

100 FULL FEMALE 90 DEGREE ELBOW

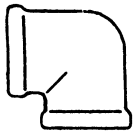

<u>PART NO.</u>	<u>PIPE SIZE</u>	<u>PRICE</u>
100-2	1/8"	3.73
100-4	1/4"	5.97
100-6	3/8"	8.20
100-8	1/2"	12.73
100-12	3/4"	27.77

101 FULL FEMALE PIPE TEE



<u>PART NO.</u>	<u>PIPE SIZE</u>	<u>PRICE</u>
101-4	1/4"	6.17
101-6	3/8"	10.30
101-8	1/2"	14.47
101-12	3/4"	31.90

103 PIPE COUPLING

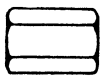

<u>PART NO.</u>	<u>PIPE SIZE</u>	<u>PRICE</u>
103-4	1/4"	3.77
103-6	3/8"	4.63
103-8	1/2"	6.27
103-12	3/4"	9.00

108 PIPE CAP



<u>PART NO.</u>	<u>PIPE SIZE</u>	<u>PRICE</u>
108-2	1/8"	1.53
108-4	1/4"	2.20
108-6	3/8"	3.47
108-8	1/2"	4.13

109 PIPE PLUG

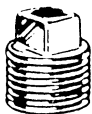

<u>PART NO.</u>	<u>PIPE SIZE</u>	<u>PRICE</u>
109-2	1/8"	1.03
109-4	1/4"	1.63
109-6	3/8"	2.23
109-8	1/2"	4.13

110 PIPE BUSHING

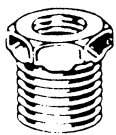

<u>PART NO.</u>	<u>M</u> <u>PIPE SIZE</u>	<u>F</u> <u>PIPE SIZE</u>	<u>PRICE</u>
110-4-2	1/4"	1/8"	1.27
110-6-4	3/8"	1/4"	1.67
110-8-4	1/2"	1/4"	2.40
110-8-6	1/2"	3/8"	2.53
110-12-4	3/4"	1/4"	5.50
110-12-6	3/4"	3/8"	5.97
110-12-8	3/4"	1/2"	5.30
110-16-12	1"	3/4"	9.93

112 CLOSE NIPPLE

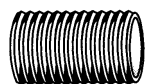

<u>PART NO.</u>	<u>PIPE SIZE</u>	<u>PRICE</u>
112-2	1/8"	0.93
112-4	1/4"	1.47
112-6	3/8"	1.97
112-8	1/2"	2.80
112-12	3/4"	6.13

116 90 DEGREE ELBOW

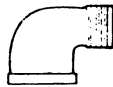

<u>PART NO.</u>	<u>PIPE SIZE</u>	<u>PRICE</u>
116-2	1/8"	2.77
116-4	1/4"	4.97
116-6	3/8"	6.20
116-8	1/2"	11.37
116-12	3/4"	21.40

118 CROSS

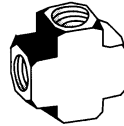

<u>PART NO.</u>	<u>PIPE SIZE</u>	<u>PRICE</u>
118-4	1/4"	11.37
118-6	3/8"	17.43
118-8	1/2"	23.03
118-12	3/4"	30.90

H46 HOSE BARB X FEMALE PIPE THREAD

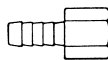

<u>PART NO.</u>	<u>I.D.</u> <u>HOSE</u>	<u>FPT</u>	<u>PRICE</u>
H46-4-2	1/4"	1/8"	1.70
H46-4-4	1/4"	1/4"	3.77

H48 HOSE BARB X MALE PIPE THREAD

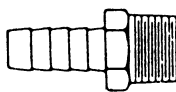

<u>PART NO.</u>	<u>I.D.</u> <u>HOSE</u>	<u>MPT</u>	<u>PRICE</u>
H48-4-2	1/4"	1/8"	1.57
H48-4-4	1/4"	1/4"	2.47
H48-4-8	1/4"	1/2"	5.59
H48-6-4	3/8"	1/4"	2.33
H48-6-6	3/8"	3/8"	3.13
H48-8-6	1/2"	3/8"	2.90
H48-8-4	1/2"	1/4"	2.63
H48-8-8	1/2"	1/2"	4.23
H48-8-12	1/2"	3/4"	10.53
H48-12-8	3/4"	1/2"	5.00
H48-12-12	3/4"	3/4"	10.53
H48-10-8	5/8"	1/2"	5.33
H48-10-12	5/8"	3/4"	10.47

9404 SWIVEL BODY - F. HOSE X F. PIPE



<u>PART NO.</u>	<u>HOSE</u>	<u>PIPE</u>	<u>PRICE</u>
9404	3/4"	3/4"	7.63

9406 MALE HOSE x MALE HOSE



<u>PART NO.</u>	<u>MALE</u> <u>HOSE</u>	<u>PRICE</u>
9406	3/4"	4.63

MALE HOSE x MALE PIPE

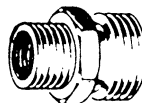

<u>PART NO.</u>	<u>MALE</u> <u>HOSE</u>	<u>MALE</u> <u>PIPE</u>	<u>PRICE</u>
9410	3/4"	1/2"	6.30
9412	3/4"	3/4"	6.17

9416 MALE HOSE x FEMALE PIPE



<u>PART NO.</u>	<u>MALE</u> <u>HOSE</u>	<u>FEMALE</u> <u>PIPE</u>	<u>PRICE</u>
9416	3/4"	3/4"	6.17

BOOM ACCESSORIES

CHAIN



<u>PART NO.</u>		<u>PRICE</u>
C-020	2/0 BOOM CHAIN STANDARD 1" BOOM	\$0.75



C-316	\$2.35
3/16" ROOF COIL HEAVY DUTY 1 1/4" BOOM	

S HOOK



<u>PART NO.</u>		<u>PRICE</u>
174-2 1/4"	S HOOK	\$0.50

U BOLTS

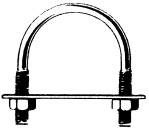

<u>PART NO.</u>		<u>PRICE</u>
U-67	FITS 3/4" PIPE	\$1.10
U-80	FITS 1" PIPE	\$1.45
U-82	FITS 1 1/4" PIPE	\$1.55
U-84	FITS 1 1/2" PIPE	\$1.50
U-87	FITS 2" PIPE	\$1.70
U-92	FITS 2 1/2" PIPE	\$2.60
U-93	FITS 3" PIPE	\$2.75

U-3358-GR5	5/8", 3 X 3 TOOLBAR	\$11.55
U-3338-GR5	3/8", 3 X 3 TOOLBAR	\$6.00



U-4458-GR5	5/8", 4 X 4 TOOLBAR	\$25.15
U-4412-GR5	1/2", 4 X 4 TOOLBAR	\$10.10
U-4434-GR5	3/4", 4 X 4 TOOLBAR	\$17.80
U-4758-GR5	5/8", 4 X 7 TOOLBAR	\$25.10
U-5558-GR5	5/8", 5 X 5 TOOLBAR	\$14.85
U-7758-GR5	5/8", 7 X 7 TOOLBAR	\$8.25

BOOM PULLEY



<u>PART NO.</u>		<u>PRICE</u>
0174	1 1/4" BOOM PULLEY	\$4.90

CHAIN SHACKLE

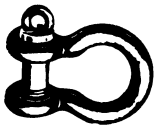

<u>PART NO.</u>		<u>PRICE</u>
193-3/16	CHAIN SHACKLE	\$1.90
193-1/4	CHAIN SHACKLE	\$2.85

EYEBOLT

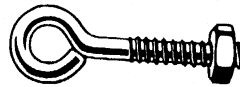

<u>PART NO.</u>		<u>PRICE</u>
EBZ-038X378	EYEBOLT W/NUT	\$1.05
EBZF-012 x 300	EYEBOLT W/NUT	\$16.28

BOOM LOCK PIN

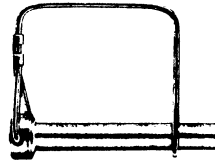

<u>PART NO.</u>		<u>PRICE</u>
P7939	BOOM LOCK PIN	\$0.75

NYLON CABLE TIES

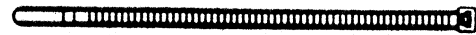

<u>PART NO.</u>		<u>PRICE</u>
NCT-9	9" LENGTH	\$0.30
NCT-15	15" LENGTH	\$0.32

LIFT PINS

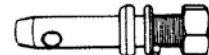

<u>PART NO.</u>	<u>DESCRIPTION</u> CATEGORY	<u>PRICE</u>
P728	1 LIFT ARM PIN	2.55
P7240	CATEGORY 2 LIFT ARM PIN	4.77

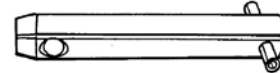

<u>PART NO.</u>	<u>DESCRIPTION</u>	<u>PRICE</u>
P7238	CATEGORY 2 DRAW PIN	11.75



<u>PART NO.</u>	<u>DESCRIPTION</u> LIFE	<u>PRICE</u>
B8319	ARM BUSHING	4.15

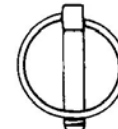

<u>PART NO.</u>	<u>DESCRIPTION</u>	<u>PRICE</u>
P791	LYNCH PIN	0.36



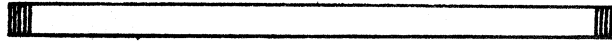

<u>PART NO.</u>	<u>DESCRIPTION</u> HITCH	<u>PRICE</u>
P700532	PIN WITH CLIP	5.80

ALUMINUM NIPPLES



<u>PART NO.</u>		<u>PRICE</u>
DT14-8-AL	1/4" X 8" STANDARD DOUBLE THREADED ALUMINUM NIPPLE FOR ADDITIONAL LENGTH - ADD PER INCH	8.73 .10
DT14-12-AL	1/4" X 12" DOUBLE THREADED ALUMINUM NIPPLE	9.07
DT14-18-AL	1/4" X 18" DOUBLE THREADED ALUMINUM NIPPLE	9.57
DT14-24-AL	1/4" X 24" DOUBLE THREADED ALUMINUM NIPPLE	10.08
DT14-30-AL	1/4" X 30" DOUBLE THREADED ALUMINUM NIPPLE	10.59
DT14-36-AL	1/4" X 36" DOUBLE THREADED ALUMINUM NIPPLE	11.10
FOR ANY LENGTH OR THREAD DESIGN OTHER THAN THOSE LISTED ABOVE, ADD \$2.00 PER NIPPLE FOR MACHINE SET-UP COST		

MISCELLANEOUS

	TEFLON THREAD SEAL COMPOUND LEAK PREVENTER, SLOW DRY-SOFT SET 8 OZ. SIZE	TEFLON TAPE 1/2" X 520"	
			
	SC-S-12 \$8.80	TT12-520 \$1.00	

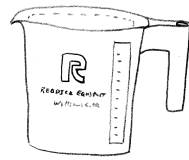
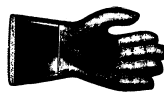
	64 OZ. CHEMICAL MEASURING PITCHER	GLOVES	
			
	RCC-64 \$10.50	BPVC-G PVC \$4.05 NITRILE GLOVES GN-G \$4.32	

DIELECTRIC GREASE PROTECTS ELECTRICAL CONNECTIONS LOCKS OUT MOISTURE	
	
49634 \$3.50	

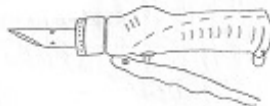
UTILITY NOZZLE	
	
URN-1 \$ 45.00	